

Specification

1. Product Type: GNSS Antenna
2. Part No: 202-008
3. Frequency: 1575.42/1602 MHz
4. Cable: RG316U
5. Connector: SMB F RA

✳️RoHS Compliant

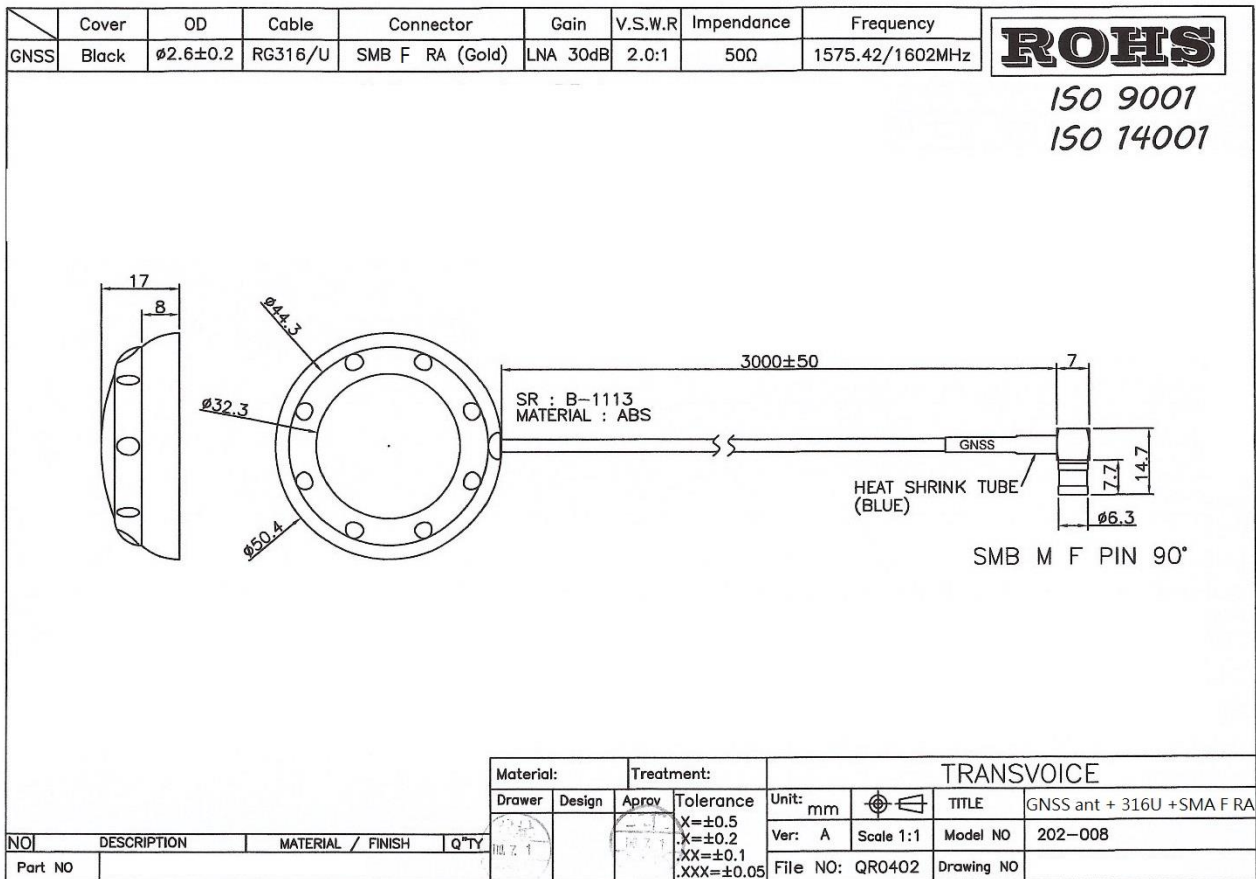

Characteristics of Ceramic Antenna

1	Antenna model	25x25x4 mm
2	Frequency Range	1575.42 & 1602 MHz
3	VSWR	2.0 max
4	Band with	10 MHz Min(Return loss -10 dB)
5	Impedance	50 ohm
6	Gain	4dBic@zenith mounted on 70mmx70mm ground plane
7	Polarization	RHCP

Characteristics of LNA

1	Frequency Range	1575.42 & 1602 MHz
2	DC current(max)	MAX 14 mA@3.3V
3	Noise Figure	1.5dB typ(+25°C±10°C)
4	LNA Gain	GPS 30dB±3dB:GLONASS 28±2dB
5	Output VSWR	1.5 max

Frequency (MHz)	Return Loss (dB)	VSWR	GAIN (dB)
1575.42	-16.41	1.36	31.41
1602	-15.74	1.42	23.55

Test Data(Return Loss & VSWR)

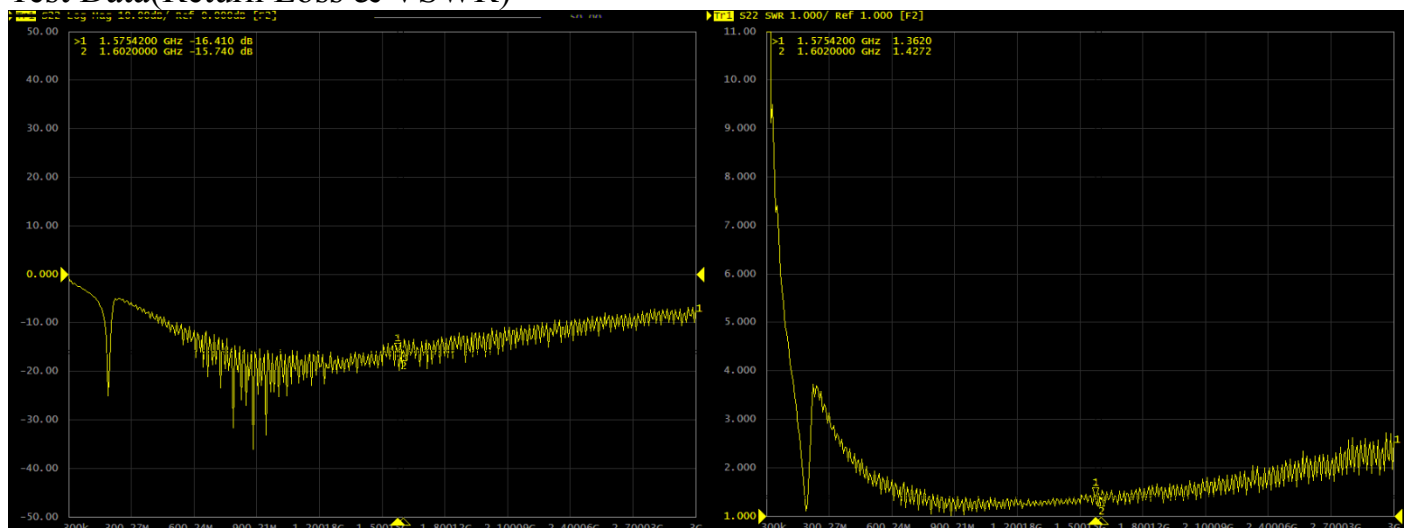

3D Test Photo

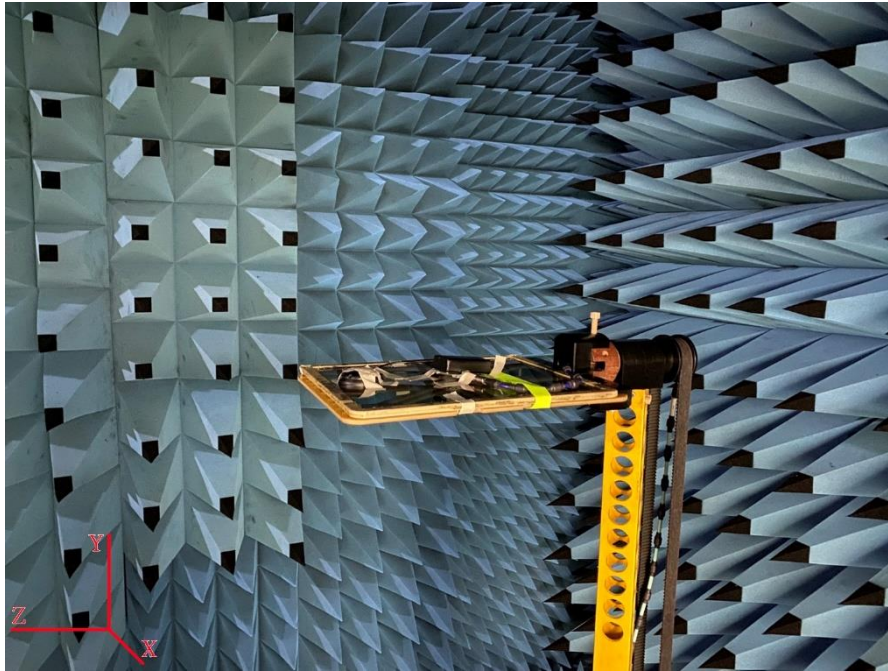

3D Test Data

Freq. / Chan.	Color
1.57542GHz	Red
1.602GHz	Blue

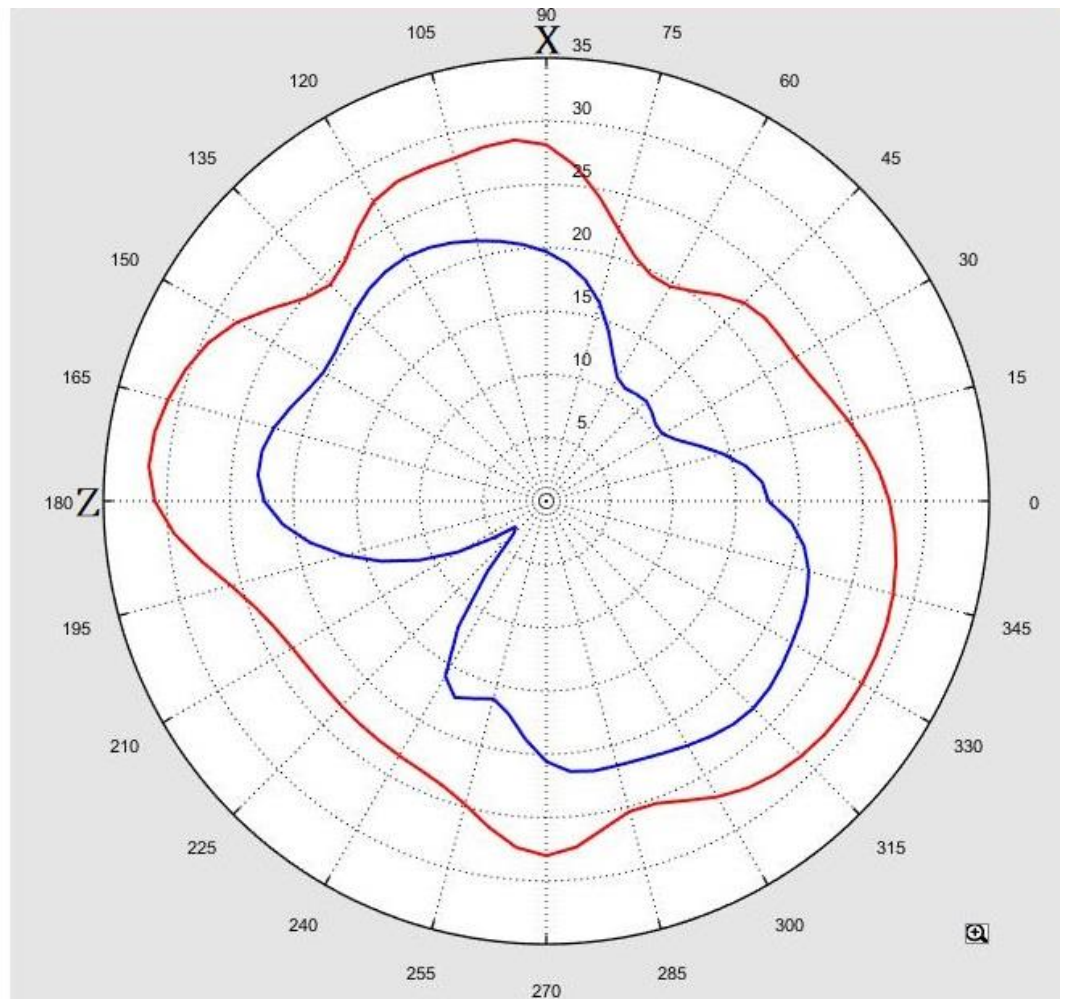

Total_Gain (dBi)

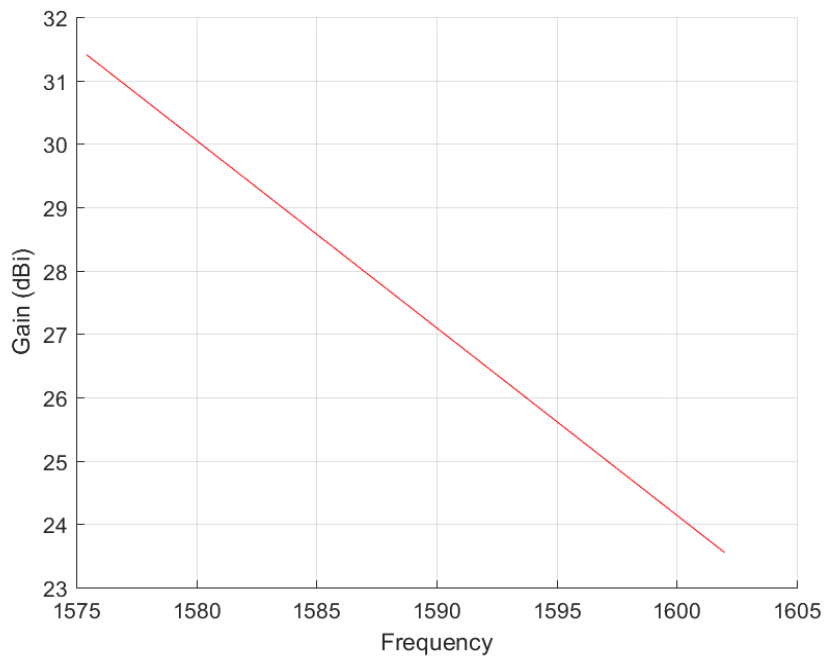

Total_3D_Top View_1.57542GHz

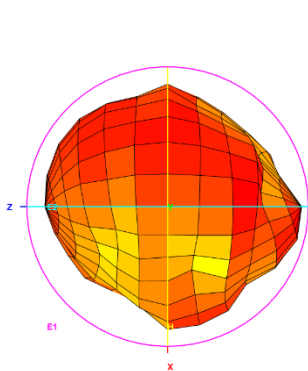

Total_3D_Front View_1.57542GHz

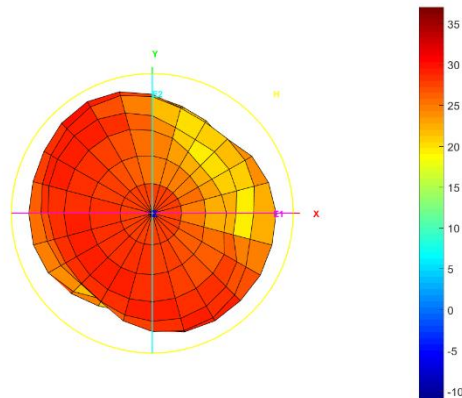

Total_3D_Left View_1.57542GHz

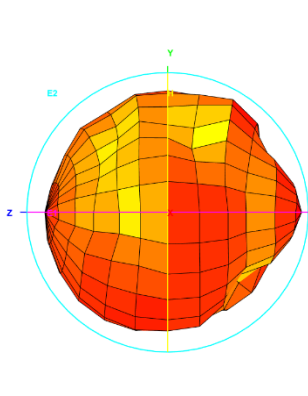

Total_3D_Side View 1_1.57542GHz

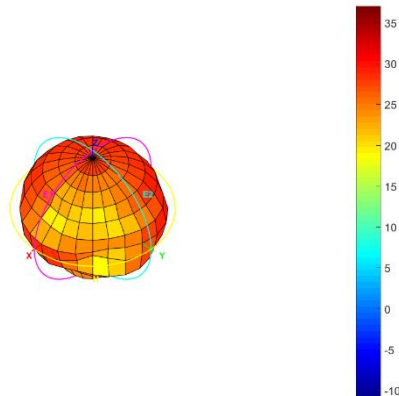

Total_3D_Top View_1.602GHz

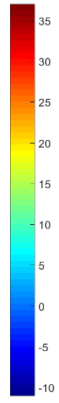
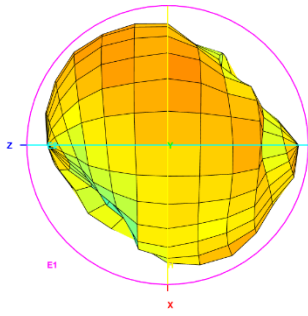

Total_3D_Front View_1.602GHz

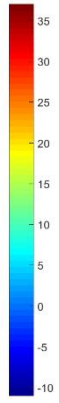
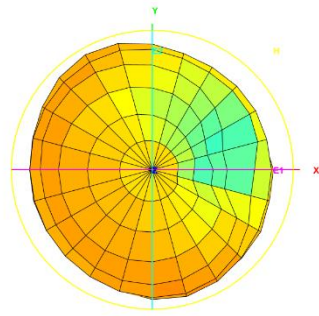

Total_3D_Left View_1.602GHz

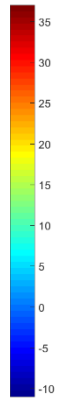
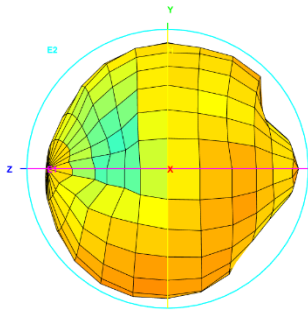

Total_3D_Side View_1.602GHz

