

Specification

1. Product Type: 5G Antenna
2. Frequency: 450~470/698~3800 MHz
3. Connector: N F
4. Impedance: 50 ohm
5. MAX Power :100W
6. Polarisation: Vertical

✧RoHS Compliant

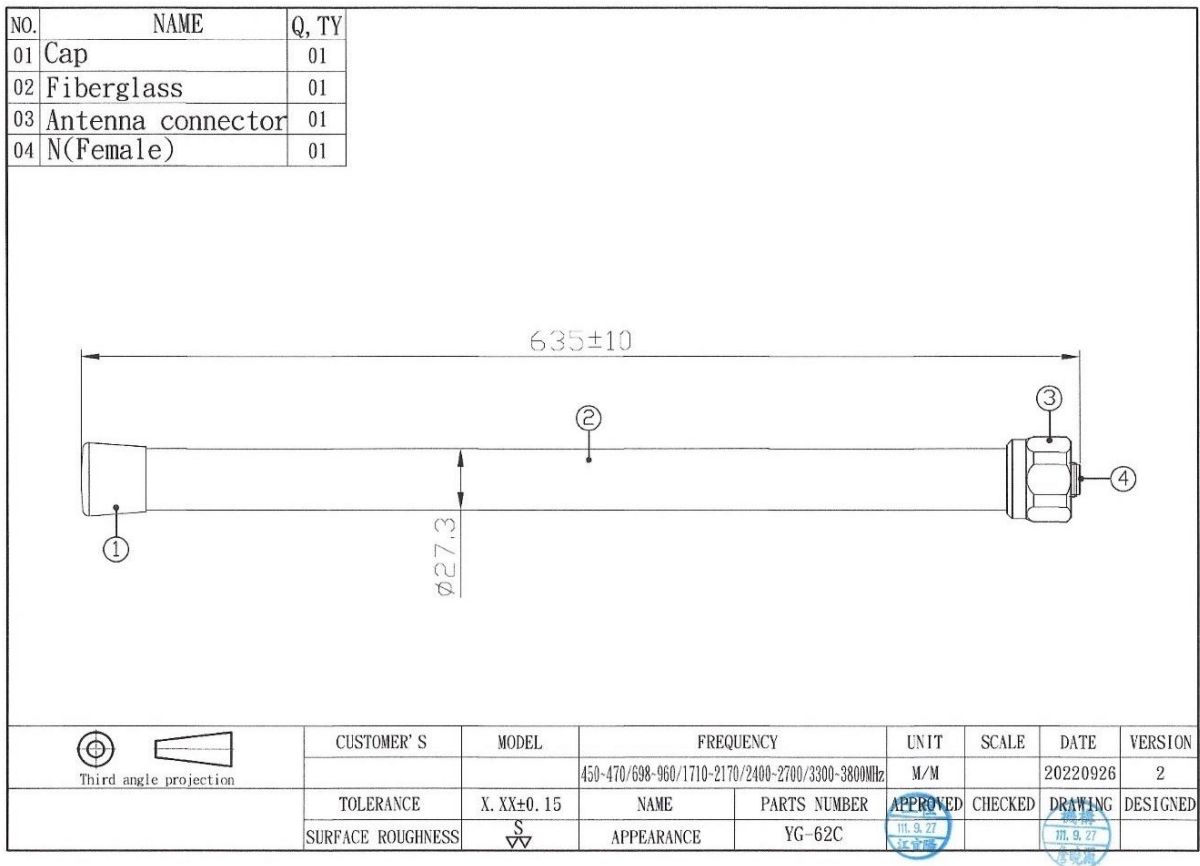

Frequency (MHz)	Return Loss (dB)	VSWR	Efficiency (%)	Gain (dBi)
450	-9.02	2.00	48.19	2.39
470	-6.20	2.81	39.9	2.15
690	-9.15	2.06	58.75	0.07
960	-6.12	2.96	69.02	2.14
1710	-7.02	2.60	43.15	1.84
2170	-22.98	1.16	59.16	2.8
2700	-13.58	1.52	60.39	4.31
3300	-6.94	2.62	46.03	1.95
3800	-6.27	2.89	36.48	2.6

Test Report (Return Loss & VSWR)

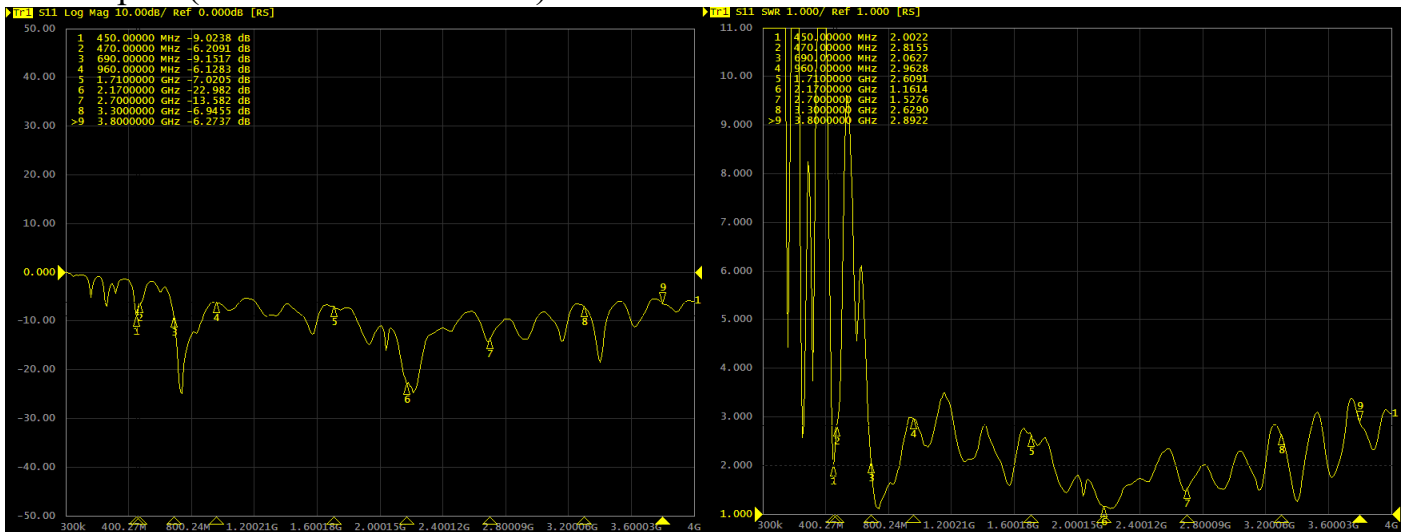

3D Test Photo

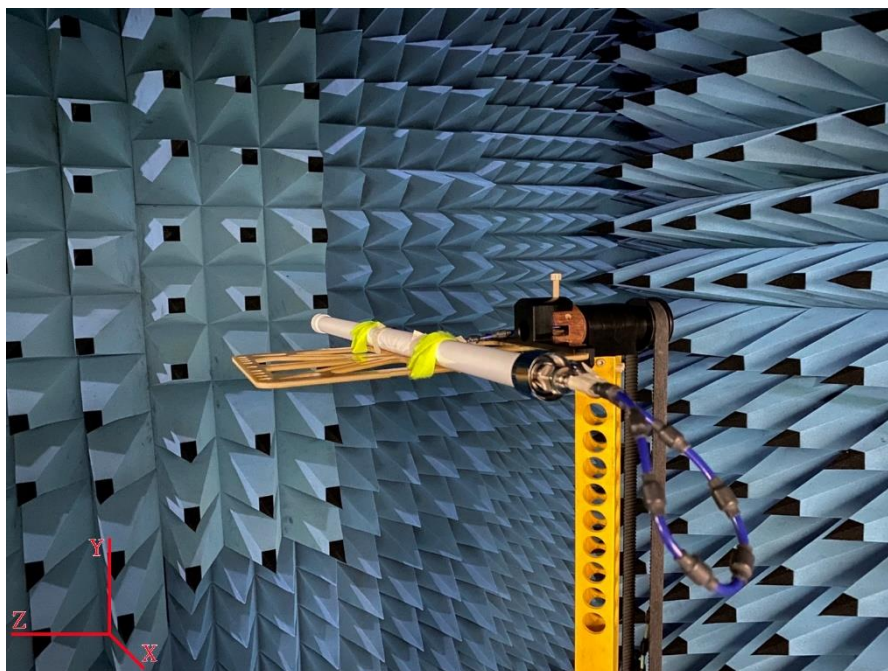

3D Test Data

Freq. / Chan.	Color
450MHz	Red
470MHz	Blue
600MHz	Green
690MHz	Magenta
824MHz	Cyan
960MHz	Yellow
1.71GHz	Black
2.17GHz	Dark Blue
2.7GHz	Light Blue
3.3GHz	Dark Green
3.8GHz	Orange

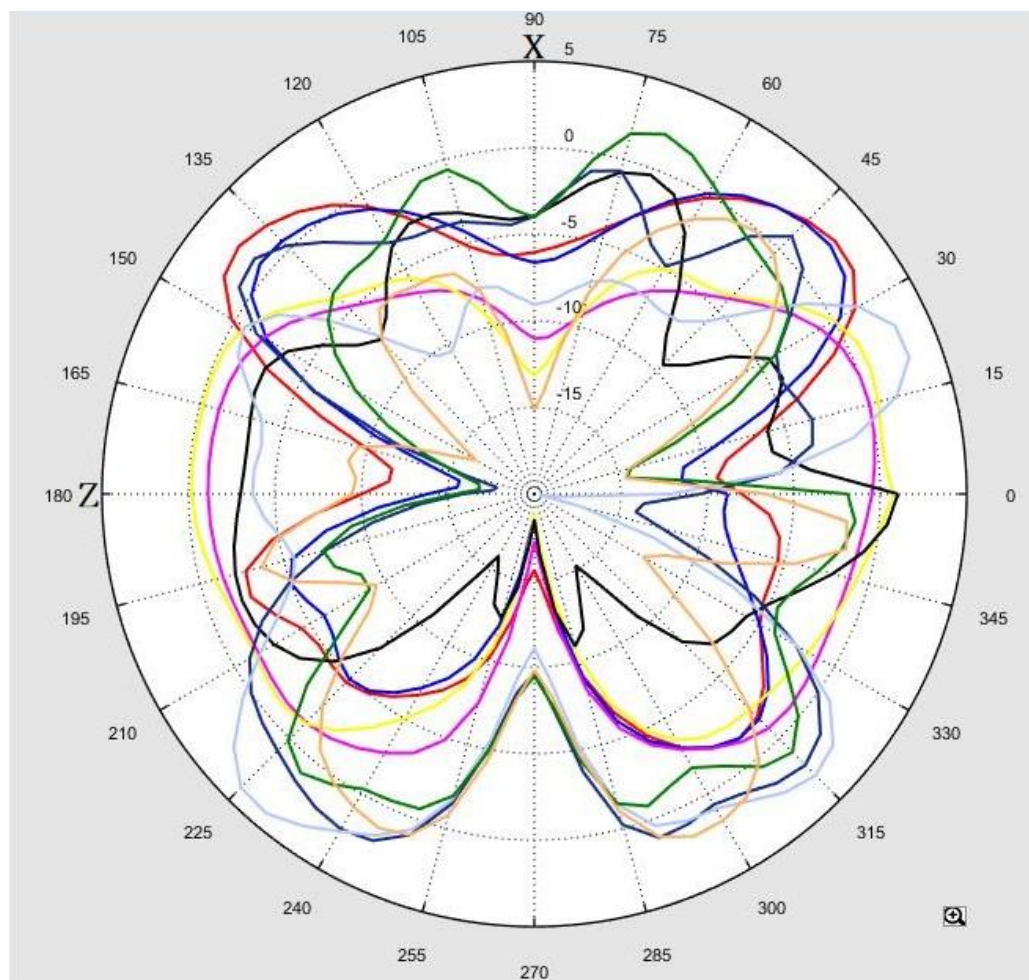

Total_Efficiency (%)

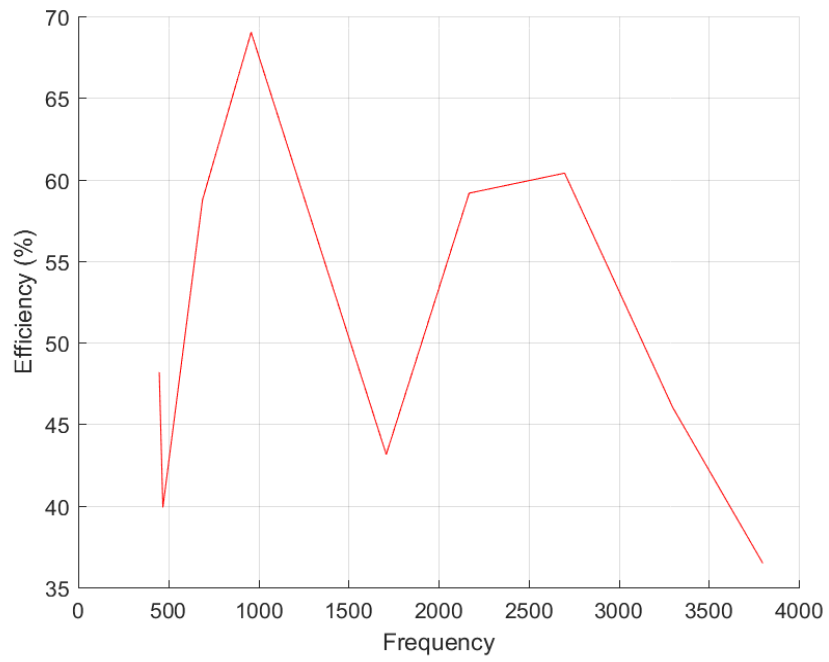

Total_Gain (dBi)

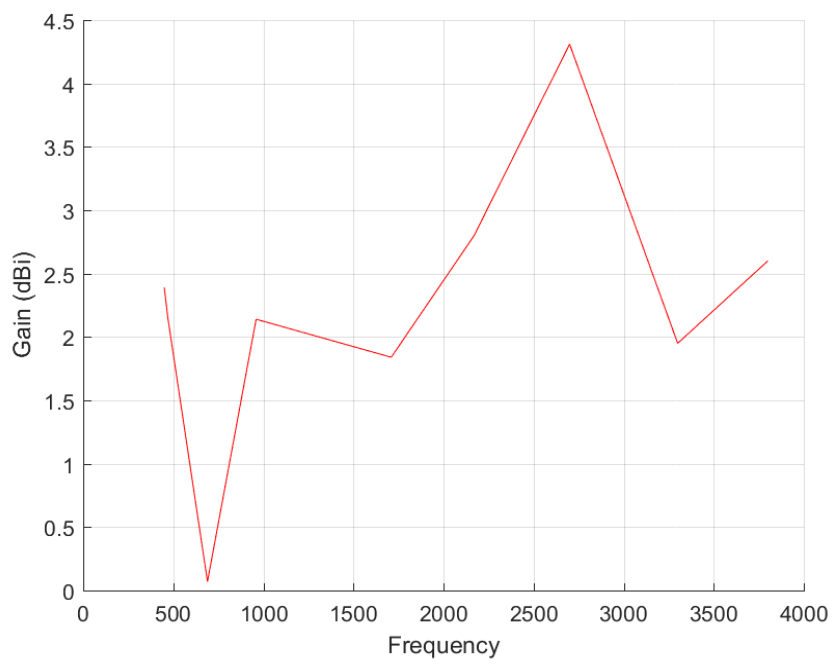

Total_3D_Top View_450MHz

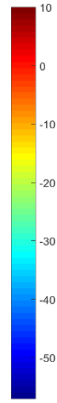
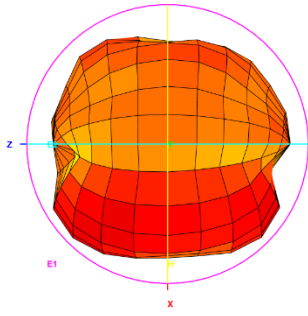

Total_3D_Front View_450MHz

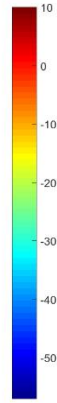
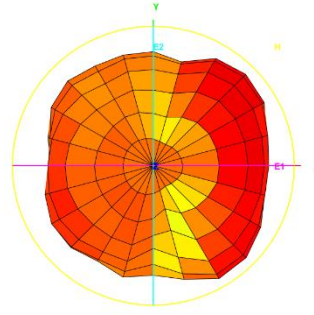

Total_3D_Left View_450MHz

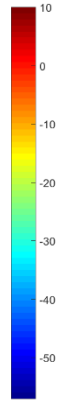
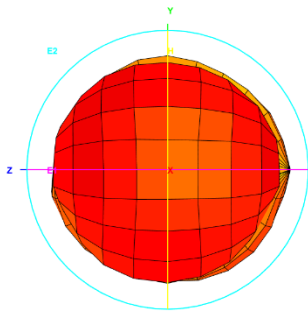

Total_3D_Side View 1_450MHz

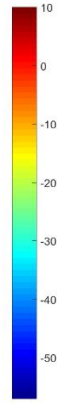
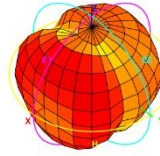

Total_3D_Top View_470MHz

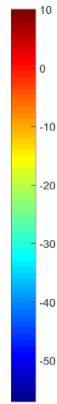
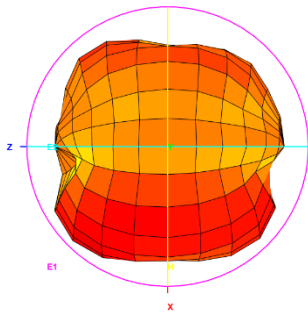

Total_3D_Front View_470MHz

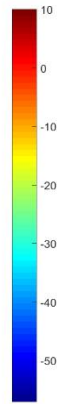
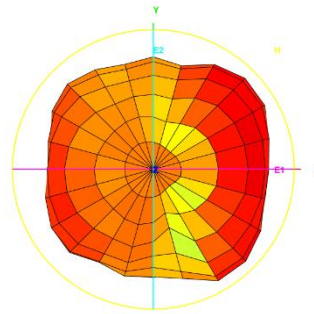

Total_3D_Left View_470MHz

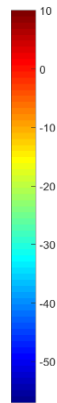
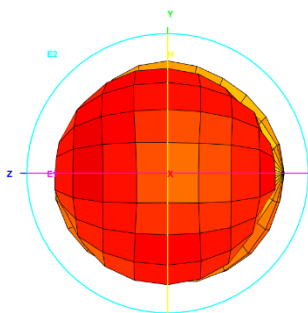

Total_3D_Side View 1_470MHz

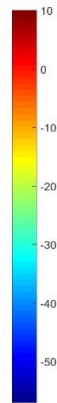
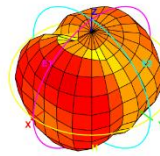

Total_3D_Top View_690MHz

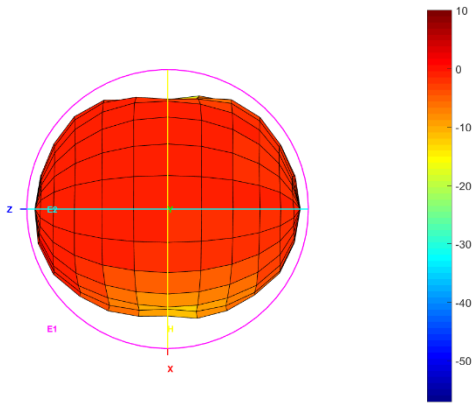

Total_3D_Front View_690MHz

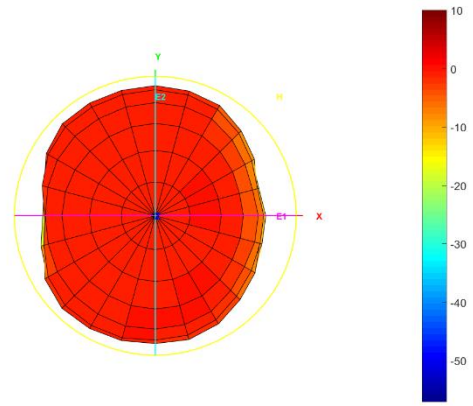

Total_3D_Left View_690MHz

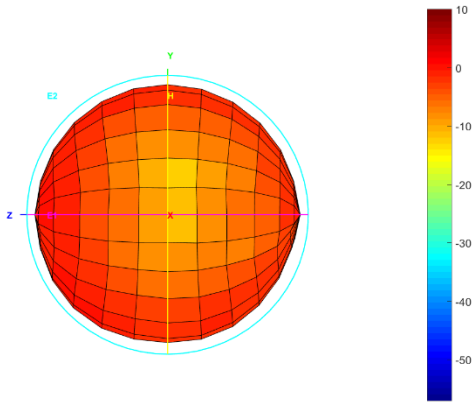

Total_3D_Side View 1_690MHz

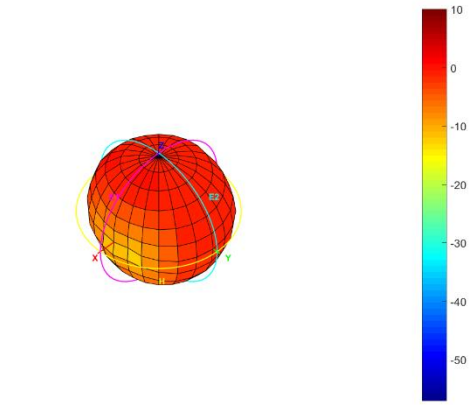

Total_3D_Top View_960MHz

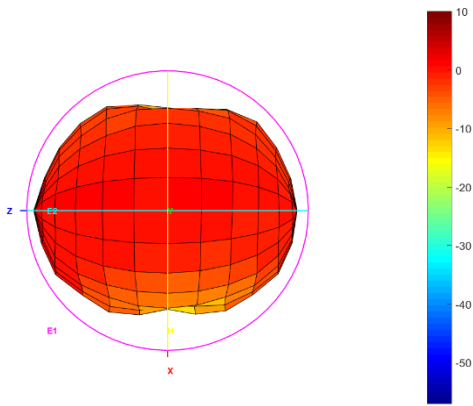

Total_3D_Front View_960MHz

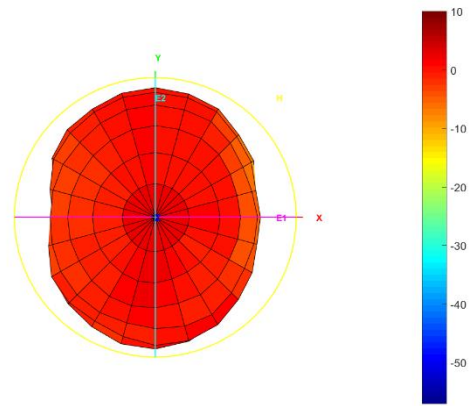

Total_3D_Left View_960MHz

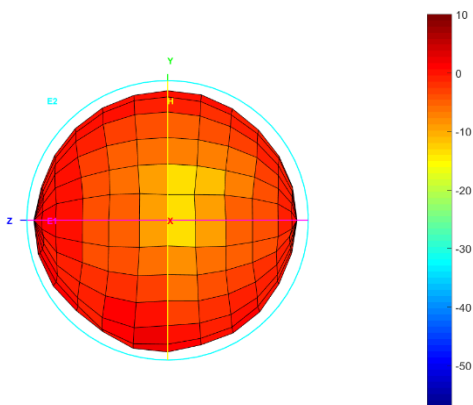

Total_3D_Side View 1_960MHz

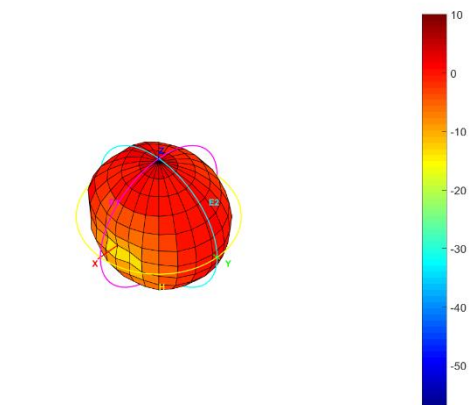

Total_3D_Top View_1.71GHz

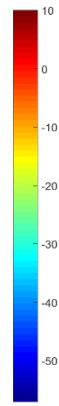
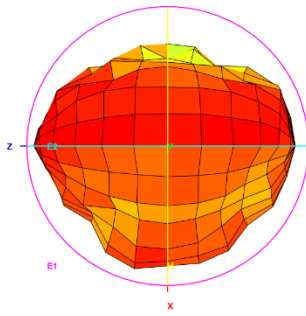

Total_3D_Front View_1.71GHz

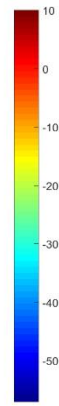
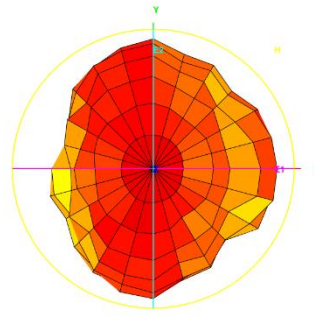

Total_3D_Left View_1.71GHz

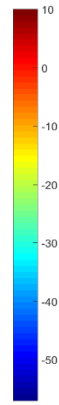
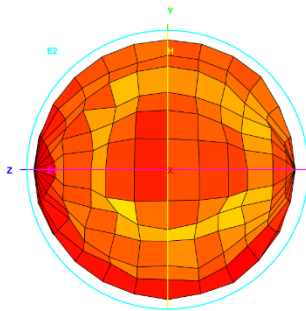

Total_3D_Side View 1_1.71GHz

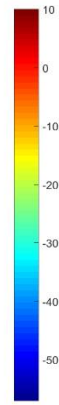
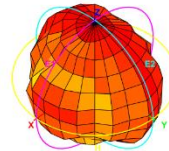

Total_3D_Top View_2.17GHz

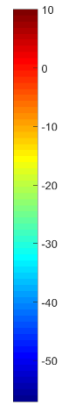
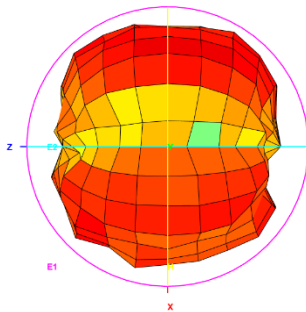

Total_3D_Front View_2.17GHz

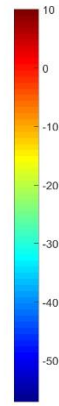
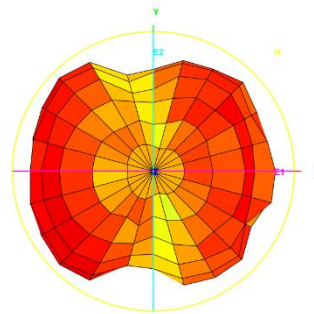

Total_3D_Left View_2.17GHz

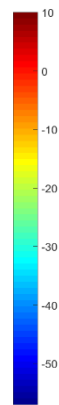
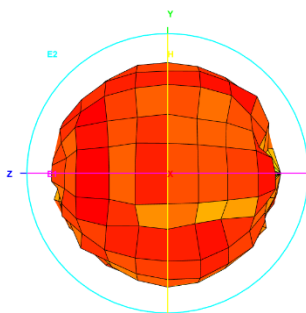

Total_3D_Side View 1_2.17GHz

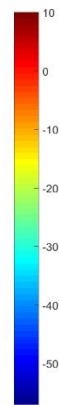
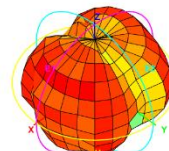

Total_3D_Top View_2.7GHz

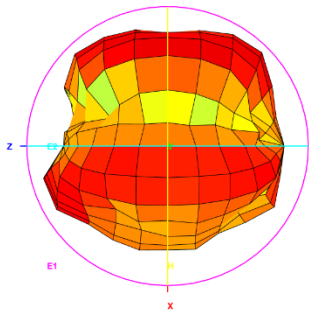

Total_3D_Front View_2.7GHz

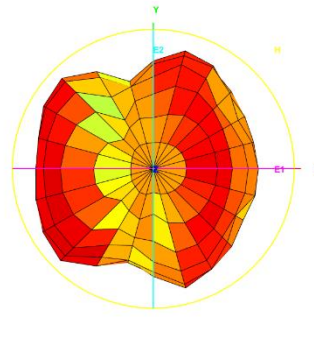

Total_3D_Left View_2.7GHz

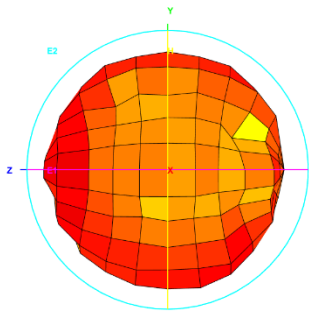

Total_3D_Side View 1_2.7GHz

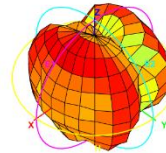

Total_3D_Top View_3.3GHz

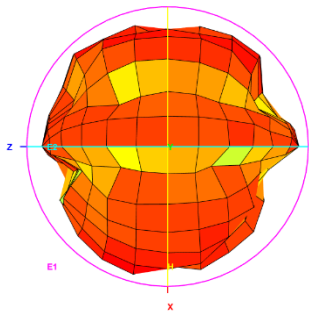

Total_3D_Front View_3.3GHz

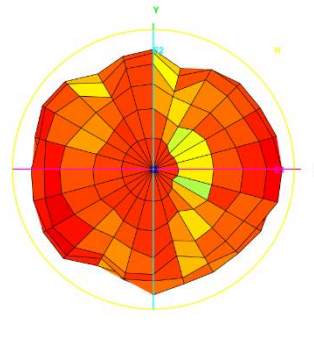

Total_3D_Left View_3.3GHz

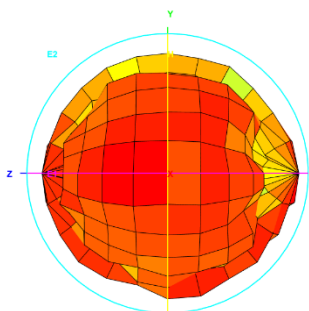

Total_3D_Side View 1_3.3GHz

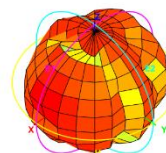

Total_3D_Top View_3.8GHz

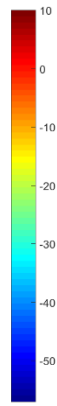
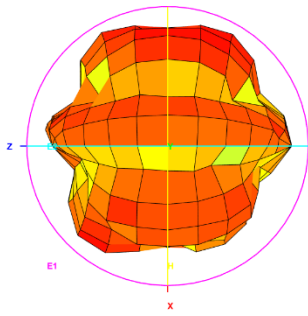

Total_3D_Front View_3.8GHz

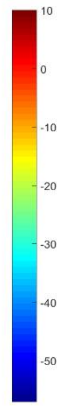
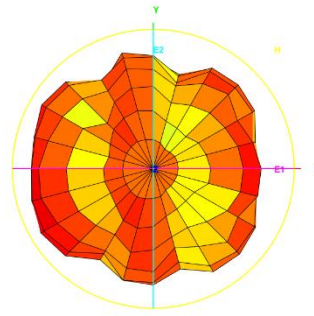

Total_3D_Left View_3.8GHz

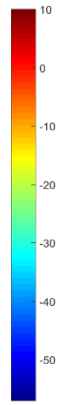
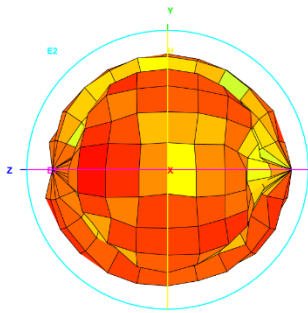

Total_3D_Side View 1_3.8GHz

