

OWNER'S MANUAL

PLEASE READ CAREFULLY BEFORE USING AND KEEP WELL

7" DIGITAL WATERPROOF FULL TOUCH MONITOR FOR HEAVY DUTY INDUSTRY

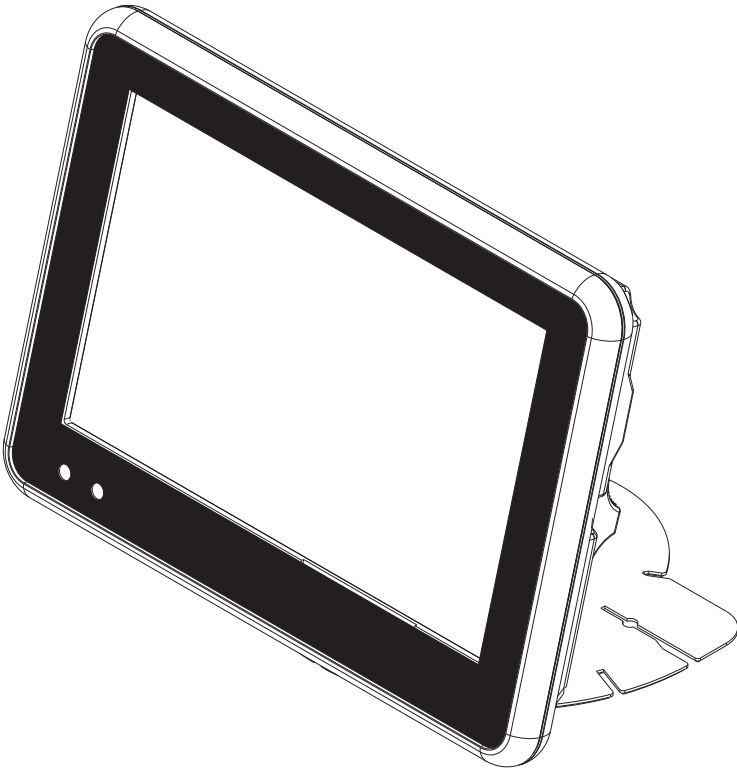

Model : ECL-AM7Q

Design and Specifications are subject to change without notice.

OWNER'S RECORD

The model and serial numbers are located on the rear of the unit. Record the serial number in the space provided below. Refer to these numbers whenever you call upon your dealer regarding this product.

Model No. : ECL-AM7Q

Serial No. : _____

WARNING

To avoid electric shock, do not open the cabinet. Refer servicing to qualified personnel only.

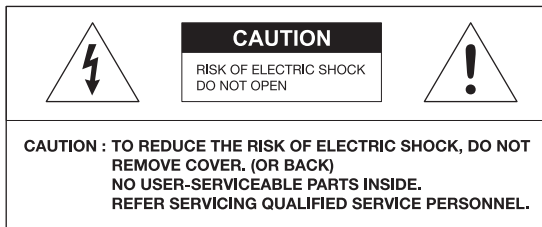

This symbol is intended to alert the user to the presence of uninsulated "dangerous voltage" within the product's enclosure that may be of sufficient magnitude to constitute risk of electric shock to persons.



This symbol is intended to alert the user to the presence of important operating and maintenance(servicing) instructions in the literature accompanying the appliance.

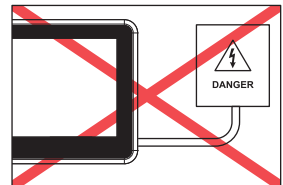
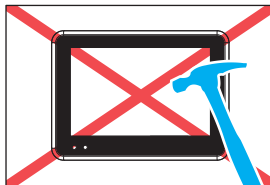
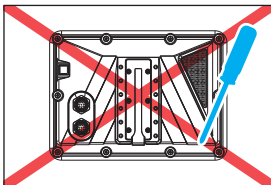

You are cautioned that any changes or modifications which is not expressed or approved in this manual could void your warranty and cause the equipment to malfunction.

CAUTION BEFORE USAGE



1. PLEASE USE THE PRODUCT AFTER READING THE MANUAL CAREFULLY FOR SAFE USAGE.

PLEASE INSTALL AND USE THE PRODUCT AFTER FULLY AWARE OF THE MANUAL AND PRECAUTION.



2. ASK EXPERIENCED TECHNICIAN FOR PRODUCT INSTALLATION.

INSTALLATION SHOULD BE DONE BY THE TECHNICIAN DUE TO PROFESSIONAL SKILLS AND EXPERIENCE IS REQUIRED.



3. DO NOT INSTALL, OPEN OR MODIFY THE PRODUCT RANDOMLY.

IT CAN CAUSE PRODUCT MALFUNCTION, ELECTRIC SHOCK, FIRE AND ALSO WATERPROOF PROBLEM FOR WATERPROOF PRODUCT. CONTACT THE SERVICE CENTER AND ASK FOR A/S, IF REPAIRS ARE NECESSARY.



4. USE REGULATED VOLTAGE.

PROTECTION CIRCUIT IS BUILT INSIDE BUT OVER VOLTAGE USAGE CAN CAUSE DAMAGE TO THE PRODUCT. MANUFACTURER WILL NOT TAKE RESPONSIBILITY FOR THE PRODUCT MALFUNCTION CAUSED BY OVER VOLTAGE.



5. DO NOT DROP OR GIVE EXTERNAL SHOCK TO THE PRODUCT.

THE PRODUCT SCREEN OR EXTERIOR CAN BE DAMAGED AND CAUSE MALFUNCTION OF THE INTERNAL PARTS. IN THIS CASE NORMAL CUSTOMER SUPPORT AND A/S CAN'T BE RECEIVED.



6. CONNECT THE MAIN POWER AFTER INSTALLATION.

IT CAN CAUSE PRODUCT MALFUNCTION, FIRE AND ELECTRIC SHOCK.



7. USE AUTHORIZED ACCESSORY & COMPONENTS.

USING UNAUTHORIZED ACCESSORY & COMPONENTS CAN CAUSE PRODUCT MALFUNCTION AND THE MANUFACTURER WILL NOT TAKE RESPONSIBILITY FOR THE MALFUNCTION.

SAFETY & CAUTION DURING USAGE



- DO NOT CUT OR DAMAGE THE CABLE RANDOMLY. IT CAN CAUSE PRODUCT MALFUNCTION OR WATERPROOF FUNCTION DEFECT. MANUFACTURER WILL NOT TAKE RESPONSIBILITY FOR THE MALFUNCTION.



- TIGHTEN THE CONNECTORS WHEN CONNECTING THE EXTENSION CABLE. OTHERWISE, IT CAN CAUSE CONNECTION PROBLEM OR WATERPROOF FUNCTION DEFECT OF THE PRODUCT.



- CHECK THE FIXED CONDITION OF THE BRACKET AND PRODUCT BEFORE DRIVING. IT CAN CAUSE DAMAGE WHILE DRIVING IN UNSTABLE CONDITION BY PHYSICAL PHENOMENONS. MANUFACTURER WILL NOT TAKE RESPONSIBILITY FOR USER'S NEGLIGENCE.



- DO NOT USE THE PRODUCT IMMEDIATELY AFTER LEAVING ALONE FOR A LONG PERIOD IN SUMMER OR WINTER. IT CAN CAUSE SERIOUS DAMAGE TO THE PRODUCT WHEN USING IN INAPPROPRIATE TEMPERATURE.



- STOP USING THE PRODUCT IMMEDIATELY IF BURNING SMELL, SMOKE OR SEVERE OVERHEATING OCCURS WHILE USAGE AND VISIT THE A/S CENTER.



- MAKE SURE TO CONNECT POWER CABLE AND CAMERA CABLE IN RIGHT DIRECTION. WRONG WIRE CONNECTION CAN CAUSE DAMAGE TO THE PRODUCT.



- DO NOT APPLY EXCESSIVE PRESSURE TO THE LCD. DUE TO PRESSURE THERE COULD BE SPOTS ON THE LCD SURFACE AND GET DAMAGED. EXCHANGE FOR THE DAMAGE IS PROVIDED AT A COST.



- WHEN USING TOUCH KEY EQUIPPED PRODUCT THE WATERPROOF FUNCTION WILL NORMALLY OPERATE, BUT IF THERE IS WATER ON THE TOUCH KEY PANEL IT COULD CAUSE MALFUNCTION. SO PLEASE REMOVE THE MOISTURE BEFORE USAGE.

SAFETY & CAUTION DURING USAGE



- DO NOT WRAP THE PRODUCT WITH ANY FABRIC WHILE OPERATING. DUE TO INTERNAL TEMPERATURE RISING, IT CAN CAUSE PRODUCT MALFUNCTION OR FIRE.



- AVOID SEVERE ELECTROSTATIC CONDITION. IT CAN CAUSE PRODUCT MALFUNCTION.



- DO NOT PILE UP HEAVY STUFF ON THE PRODUCT. IT CAN CAUSE PRODUCT PROBLEMS OR DAMAGE.



- DO NOT PRESS SEVERAL BUTTONS AT THE SAME TIME.



- IF ANY DEBRIS IS FOUND INSIDE OF THE PRODUCT, DISCONNECT THE POWER CABLE AND VISIT THE A/S CENTER. IT CAN CAUSE ELECTRIC SHOCK OR MALFUNCTION WHEN USED CONTINUOUSLY.



- DO NOT CLEAN THE PRODUCT WITH CHEMICAL PRODUCT. (ALCOHOL, BENZENE, ACETONE AND ETC) IT CAN CAUSE DAMAGE OF THE PRODUCT SURFACE OR PRODUCT MALFUNCTION.

SUGGESTIONS

7 Inch **DIGITAL WATERPROOF FULL TOUCH MONITOR FOR HEAVY DUTY INDUSTRY**

1 Safety

Use only DC 9V ~ DC 80V.

If liquid or dust leaks into the case, turn off power to the unit and consult an experienced technician before using.

2 Installation

Do not install the units in an extremely hot or humid place (radiator, air duct, etc.) or in a place subject to direct sunlight, excessive dust, mechanical vibration or shock.

If your vehicle has been parked in direct sun light resulting in a considerable rise in temperature inside the vehicle, allow the unit to cool off before operating.

3 General cleaning information

Clean the unit with a slightly damp soft cloth. Use a mild household detergent.

Never use strong solvents such as thinner or benzene as they might damage the finish of the unit.

FEATURES

ECL-AM7Q (7" Digital High Resolution Full Touch LCD Monitor) is especially designed as automotive all round vision system.

- Water Proof (IP69K)
- 7" Full Touch Digital LCD Wide Panel
- Auto NTSC / PAL Detection
- A-HD / A.T(TVI) / CVI Detection
- Auto DAY / NIGHT Detection
- Vandal Resistance (AI Housing)
- Parking Distance Marker Setting Available
- Capacitive Touch Sensor
- Multiple Display Modes (SINGLE, SPLIT, TRIPLE, PIP, QUAD)
- Support Multi-Functional Camera (CAM 1, 2, 3, 4): Normal/Shutter/Tilt

PACKAGE CONTENTS

Please check that you have the correct contents before using this product. If any items are missing, please contact your dealer.



ECL-AM7Q MONITOR

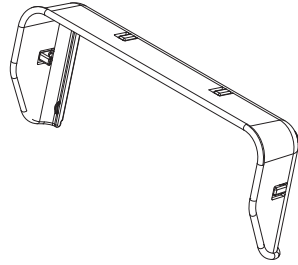

SUN VISOR

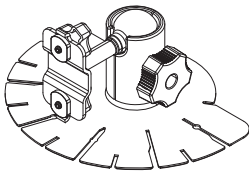

RAIL TYPE

OR

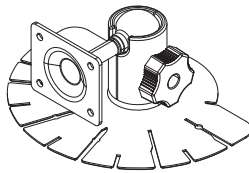

SCREW TYPE

STAND BRACKET
(OPTIONAL)

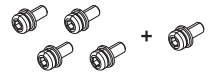

M4 x 10L (4 + 1)

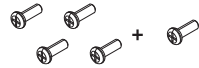

T3 x 10L (4 + 1)

SCREW KITS

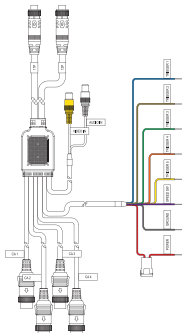

4 PIN IP TYPE
CAMERA CONNECTOR

OR

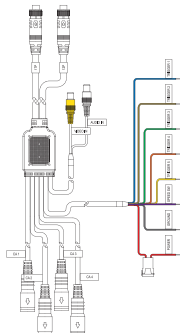





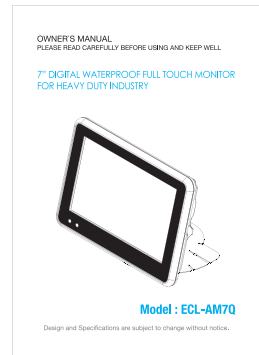



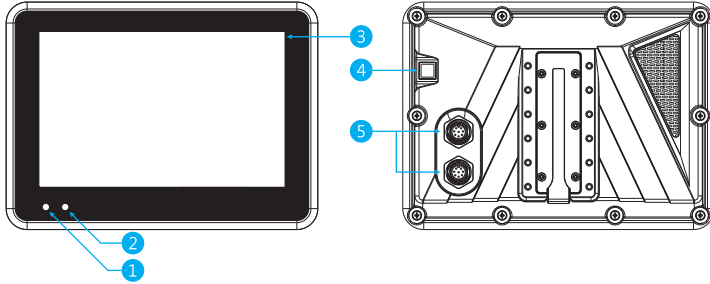





4 PIN DIN TYPE
CAMERA CONNECTOR

POWER CORD



INSTRUCTION
MANUAL











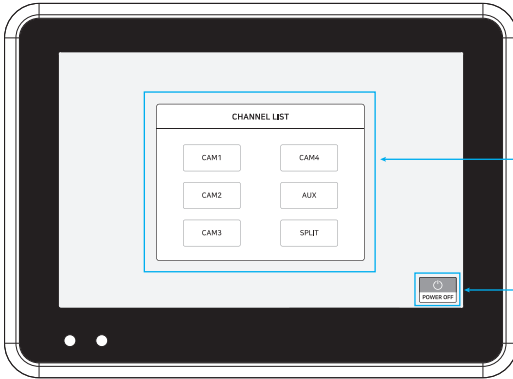



1	POWER	<ul style="list-style-type: none"> ■ Touch twice screen rapidly to turn the monitor on. ■ Touch  to turn the monitor off at CHANNEL LIST menu. * CHANNEL LIST content can be found in pg. 9 															
2	DAY / NIGHT SENSOR	<ul style="list-style-type: none"> ■ Automatic Brightness Control The brightness of the monitor is adjusted automatically with the DAY / NIGHT SENSOR accordingly to the circumstance. 															
3	SCREEN	<ul style="list-style-type: none"> ■ Space for input and display at the same time. ■ The monitor can be operated through four touch methods. <table border="1" style="width: 100%; text-align: center;"> <thead> <tr> <th></th> <th>Touch</th> <th>Double Touch</th> <th>Long Touch</th> <th>Touch and Drag</th> </tr> </thead> <tbody> <tr> <td>Time</td> <td>more than 0.5sec</td> <td></td> <td>more than 2 sec</td> <td></td> </tr> <tr> <td>ICON</td> <td></td> <td> x2</td> <td></td> <td></td> </tr> </tbody> </table>		Touch	Double Touch	Long Touch	Touch and Drag	Time	more than 0.5sec		more than 2 sec		ICON		 x2		
	Touch	Double Touch	Long Touch	Touch and Drag													
Time	more than 0.5sec		more than 2 sec														
ICON		 x2															
4	Reset	<ul style="list-style-type: none"> ■ When Monitor is crashed and stop operating, Push This button to shut down the monitor. 															
5	Plug	<ul style="list-style-type: none"> ■ Connect two Power Cords (12 Pin and 17 Pin Cable) to Plug. You must connect both cables to operate ECL-AM7Q. 															

NOTE : Monitor start mode will follow “ADVANCED MENU ▸ AUTO POWER” (pg. 18)

CHANNEL LIST

■ Entering CHANNEL LIST MENU



1	CHANNEL LIST	<ul style="list-style-type: none"> ■ Selectable CHANNEL displayed. ■ Selecting a channel displays a single full screen for the selected channel. As an exception, SPLIT displays two channels on side by side. 						
2	POWER OFF	<table border="1" style="width: 100%;"> <tr> <td style="text-align: center;">  POWER OFF </td> <td style="text-align: center;">  Touch (more than 0,5 sec) </td> <td> Touch more than 0.5 seconds. The Monitor is turned off and returns to "STAND BY" Mode. </td> </tr> <tr> <td style="text-align: center;">  Screen </td> <td style="text-align: center;">  Double Touch </td> <td> To turn on the Monitor from "STAND BY" Mode. Touch the screen twice. </td> </tr> </table> <p>NOTE : While AUTO SCAN function activate, user can not pop up CHANNEL LIST menu on the screen.</p>	 POWER OFF	 Touch (more than 0,5 sec)	Touch more than 0.5 seconds. The Monitor is turned off and returns to "STAND BY" Mode.	 Screen	 Double Touch	To turn on the Monitor from "STAND BY" Mode. Touch the screen twice.
 POWER OFF	 Touch (more than 0,5 sec)	Touch more than 0.5 seconds. The Monitor is turned off and returns to "STAND BY" Mode.						
 Screen	 Double Touch	To turn on the Monitor from "STAND BY" Mode. Touch the screen twice.						

MENU

■ Entering MENU MENU

Touch Screen for Long Touch (over 2 seconds) to pop up MENU.

Selectable MENU disappears within 7 seconds if there is no more touch input.



1	Main Menu	<ul style="list-style-type: none"> ■ Selectable Main Menu displayed. ■ Each main menu has its own sub menu. Touch the Main Menu to enter Sub Menu
2	Sub Menu	<ul style="list-style-type: none"> ■ The Main Menu is selected by touch, the Sub Menu will be displayed on the right side of the Main Menu.
3	Page Indicator	<ul style="list-style-type: none"> ■ If all Sub Menu can not be displayed on the screen, Page Indicator is activated. ■ Touch button to move on to the next page.
4	ESC	<ul style="list-style-type: none"> ■ Touch to escape MENU

1 DISPLAY

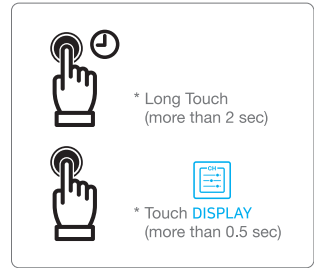

■ CH SELECT Setting

- Select the channel you want to set.
Each channel can have different settings.

■ VOLUME Setting

- Adjust the Volume of Monitor.
Move Dots to the desired setting value.

■ BRIGHT or CONTRAST Setting

- Brightness means Color's Lightness on the screen.
Contrast means contrast of different Colors
Move Dots to adjust Brightness or Contrast.

■ COLOR or TINT Setting

- Color means the Color shown on the screen.
Tint means the amount of white added to the original color.
Move Dots to adjust Color or TINT.

■ SHARPNESS Setting

- Sharpness means the clarity displayed on the screen.
Move Dots to adjust Sharpness.

2 INPUT MENU

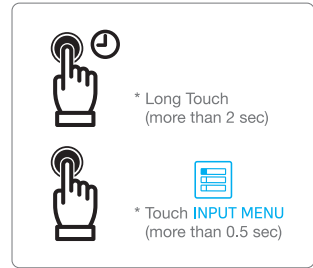

■ CH SELECT Setting

- Select the channel you want to set.
Each channel can have different settings.

■ NOR/MIR or UP/DOWN Setting

- NOR/MIR Menu is adjust Normal or Mirror view Setting.
Mirror View is vertical reflect of Normal View.
- UP/DOWN Menu is adjust Up or Down view Setting.
Down View is horizontal reflect of Up View.
Move Dots to the desired setting value.



< Normal View >



< Mirror View >







< Up View >



< Down View >

■ SORT Setting

- Select the type of Camera.
Different types of camera (Normal / Shutter / Tilt) can be connected to each channel.
Some Type of Camera has additional setting options.

X SERIES		Turn the White LED ON and OFF of the X SERIES Camera
MANUAL TILT		Adjust View Angle of the Tilt Camera by touching Arrow  

3 TRIGGER MENU

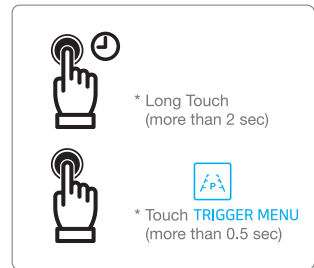

■ TRG SELECT and SOURCE Setting

- User can use up 5 triggers and each trigger source can be selected.

■ DELAY Setting

- Delay time of each trigger is adjustable 0 to 30 seconds.
Move Dots to the desire setting value.

📌 **NOTE :** If one camera is activated by an intermittent or wave signal (e.g directional lights) the delay should be set enough longer than wave length to prevent flickering picture.

■ MARKER and MARKER SETTING Setting

- If **MARKER** is set to ON, Parking Marker is visible on screen when trigger is enabled.
Move Dots to the desire setting value.

- Adjust the position and width of Parking Marker by touch and drag.

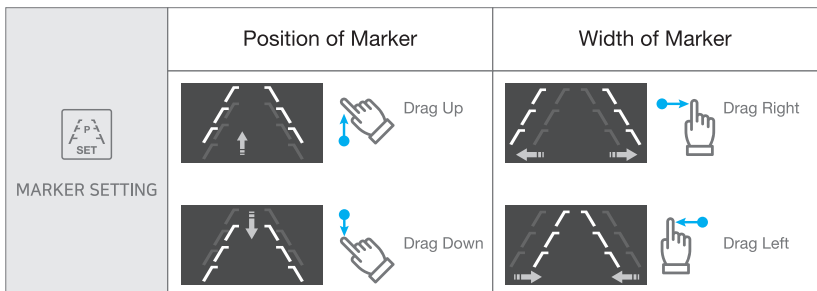

4 SPEED PULSE

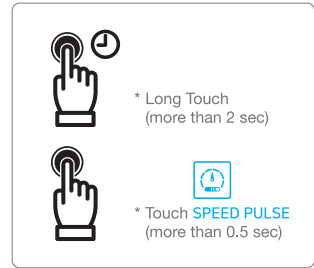

■ **FUNCTION ON/OFF** Setting

- Select 'ON' for enter into the function and 'OFF' for get out the function.
- The **PURPLE wire** needs to be connected with the vehicle's tacho signal and via MENU the SPEED PURSE needs to selected ON.
- * **Wire Color can be changed, check the named sticker on wire first.**

■ **FREQUENCY** and **UNDER FREQUENCY CH** Setting

- Selectable activated Frequency is 10 to 1,000Hz.
Touch ▲ ▼ arrow to adjust Frequency value.
- Different type of tacho signal has different Frequency value for the same speed.
- When the speed selected in FREQUENCY is exceeded, the image of the camera selected in UNDER FREQUENCY CHANNEL is turned off.
When the speed slows down, then the selected camera will be ON automatically again at same frequency.

■ **OVER FREQUENCY DISPLAY** and **OVER FREQUENCY CH** Setting

- Instead of automatic switch OFF at over Frequency it is also possible to activate another Video source.
- In this case, user needs to select **OVER FREQUENCY DISPLAY ON**, and select **OVER FREQUENCY CHANNEL**

5 DISPLAY MODE

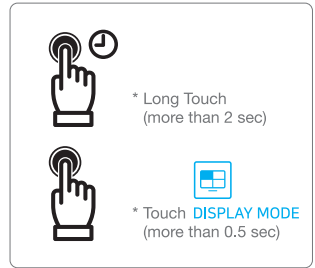

■ **DISPLAY TYPE** and **DISPLAY VIEW TYPE** Setting

- Select the number of Cameras displayed on the screen.

After Set **DISPLAY TYPE**, Choose **DISPLAY VIEW TYPE**.

To Select display view type, Touch the  **DISPLAY VIEW TYPE** to activated pop up menu.

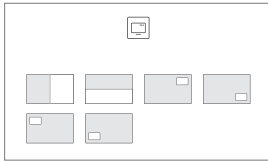

< SPLIT DISPLAY TYPE >

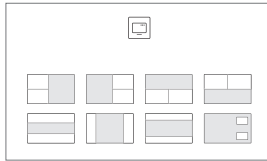

< TRIPLE DISPLAY TYPE >

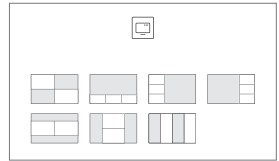

< QUAD DISPLAY TYPE >

■ **SOURCE 1** **SOURCE 2** **SOURCE 3** **SOURCE 4** **SOURCE 1~4** and **AUDIO** Setting

- Selected camera can not be selected again in same split mode.

- Audio function is only available on selected channel.

Move Dots to the desire setting value.

NOTE : CAM 4 and AUX cannot be set at the same time.

6 DAY / NIGHT

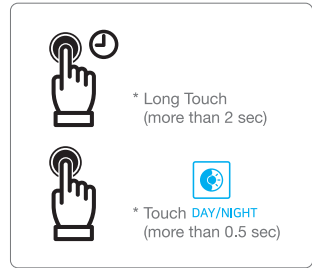

■ FUNCTION ON/OFF Setting

- DAY / NIGHT Sensor detects the illumination intensity and, if dark, NIGHT Mode will be activated.

■ SENSITIVITY Setting

- Adjust the sensitivity of DAY/NIGHT level.
Higher values make to activate Night Mode in darker environments.
If you want to activate Night Mode in a brighter environment, lower the value.

■ NIGHT BRIGHT Setting

- Adjust the Brightness of screen while Night Mode is activated.
Move Dots to the desired setting value.

7 AUTO SCAN

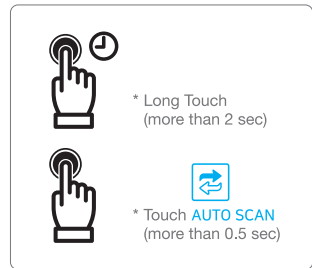

■ FUNCTION ON/OFF Setting

- The Function to play or skip each channel display on the screen in preset order.
- Touch the screen to PAUSE **AUTO SCAN** and touch again to **AUTO SCAN**.

 **NOTE :** While **AUTO SCAN** function activate, user can not pop up **CHANNEL LIST** menu on the screen.

■ // // CAM 1~4, AUX, SPLIT Delay Setting

- Adjust the amount of time each screen plays when **AUTO SCAN** function is activated.
- Each channel can set the time from 0 to 30 seconds.
Selected Channel will be skip if you set Delay time to "0".

8 ADVANCED MENU

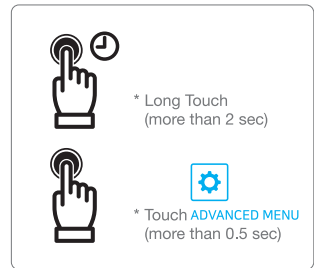

■ **AUTO POWER** Setting

- **AUTO POWER ON**

Monitor will be turned on automatically when ignition key on regardless of the last mode of the monitor before the ignition key off.

- **AUTO POWER OFF**

Monitor keeps “STAND BY” setting regardless of the last mode of the monitor before the ignition key off.

- **AUTO POWER AUTO**

Monitor will start up “POWER ON” or “STAND BY” mode according to its last mode of the monitor before the ignition key off.

■ **FACTORY RESET** Setting

- Reset for Factory Setting.

■ **MENU LOCK FUNCTION** Setting

- Passwords can be used to prevent users from accessing the menu.

INSTALLATION

DASH BOARD → BRACKET + MONITOR

SCREW FIXING TYPE STAND BRACKET

1

Peel off
release paper



2

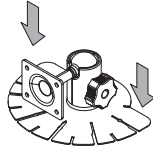

Fix on dash board

3

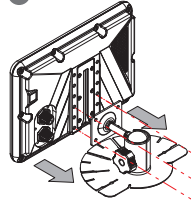

Fix tapping screw

4

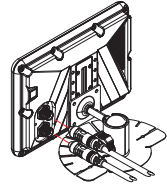

Connect Power Cord

RAIL TYPE STAND BRACKET

1

Peel off
release paper



2

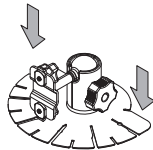

Fix on dash board

3

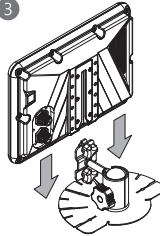

Fix hand screw

4

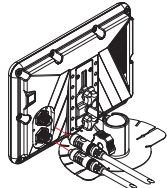

Connect Power Cord

SUN VISOR + MONITOR

Slide the Sun Visor from top to bottom of the ECL-AM7Q to assemble.

1

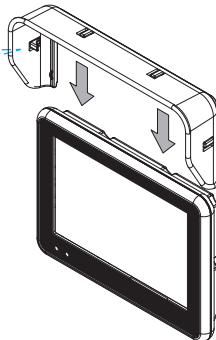

2

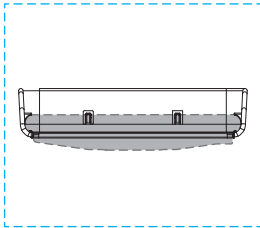
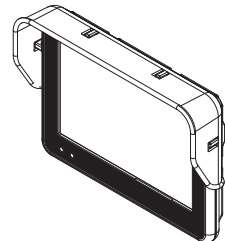

SYSTEM CONNECTIONS

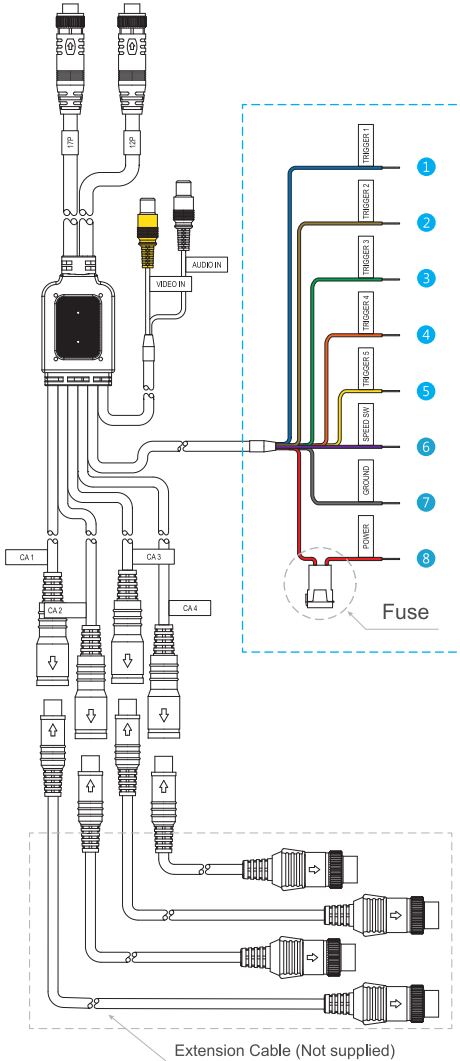

No.	Description
1	Trigger 1 (BLUE)
2	Trigger 2 (BROWN)
3	Trigger 3 (GREEN)
4	Trigger 4 (ORANGE)
5	Trigger 5 (YELLOW)
6	Speed Switch (PURPLE)
7	Ground (BLACK)
8	Power (RED) DC 9V ~ 80V

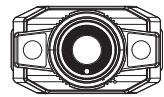

Normal Camera

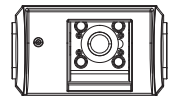

Tilt Camera

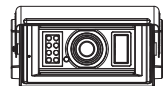

Shutter Camera

* Camera is not supplied

CAMERA 4 →

CAMERA 3 →

CAMERA 2 →

CAMERA 1 →

Extension Cable (Not supplied)

MODEL : ECL-AM7Q

Power Input	DC 9V ~ 80V
Power Consumption	Max. 30 Watt
Video System	NTSC / PAL A-HD compatible
Panel	7 Inch Digital
Resolution	1280 (H) × 3 (RGB) × 800 (V) pixels
Format	16 : 10 Wide
Display Mode	Single / Split / Triple / Quad / PIP
Camera input (4 CH)	Mini 4 PIN DIN CONNECTOR or 4 PIN IP CONNECTOR 1Vp-p 75Ω
Operating Temperature	-40°C ~ 70°C (-40°F ~ 158°F)
Storage Temperature	-40°C ~ 85°C (-40°F ~ 185°F)
Vibration	10G
I.P Factor	IP 69K
OSG Control	Day & Night Sensor, Speed Pulse, Auto Scan Bright, Contrast, Color, Tint, Sharpness Mirror/Normal, Up/Down, Day/Night Mode/Scale Display Mode (Single/Split/Triple/Quad/PIP) * Individual Control per Channel available
Dimension	193(W) × 141(D) × 32(H) mm 7.6(W) × 5.5(D) × 1.3(H) inch
Weight	Approx. 840g (1)
Supplied accessory	Sun Visor (1) Stand Bracket (Optional) (1) Power Cord (1) Screw Kit (1) Instruction Manual



THIS SYMBOL MEANS DO NOT DISPOSE OF AS MUNICIPAL WASTE.

RE-USE OR RECYCLE WHEREVER POSSIBLE.
ELECTRICAL / ELECTRONICALLY COMPONENTS MAY CONTAIN
SUBSTANCES WHICH ARE HARMFUL TO THE ENVIRONMENT.

FOR ENVIRONMENTALLY SOUND METHODS OF DISPOSAL,
PLEASE CONTACT YOUR LOCAL GOVERNMENT AUTHORITY.

“ Perfect Quality, On-Time Delivery & Speedy A/S ”

* Design and specifications are subject to change without notice.

* Patent registered.

Part No. 6MNELAM7Q-00
printed in Korea

