

Specification

- 1. Product Type: AMS Antenna*
- 2. Frequency: 690~3800MHz*
- 3. Cable and connector: 2m RG316 + MCX M RA*
- 4. Testing on IRON SHEET*

✧RoHS Compliant



Frequency (MHz)	Return Loss (dB)	VSWR	Efficiency (%)	Gain (dBi)
690	-4.59	3.87	8.2	-7.8
824	-6.84	2.66	17.46	-3.93
960	-8.91	2.10	45.81	0.72
1710	-9.34	2.04	37.93	4.43
1880	-11.28	1.74	46.34	6.52
2170	-13.21	1.56	44.26	4.9
2700	-17.34	1.31	53.95	6.93
3300	-15.51	1.40	65.31	7.32
3800	-10.87	1.79	55.46	4.95

Test Report(Return Loss & VSWR)

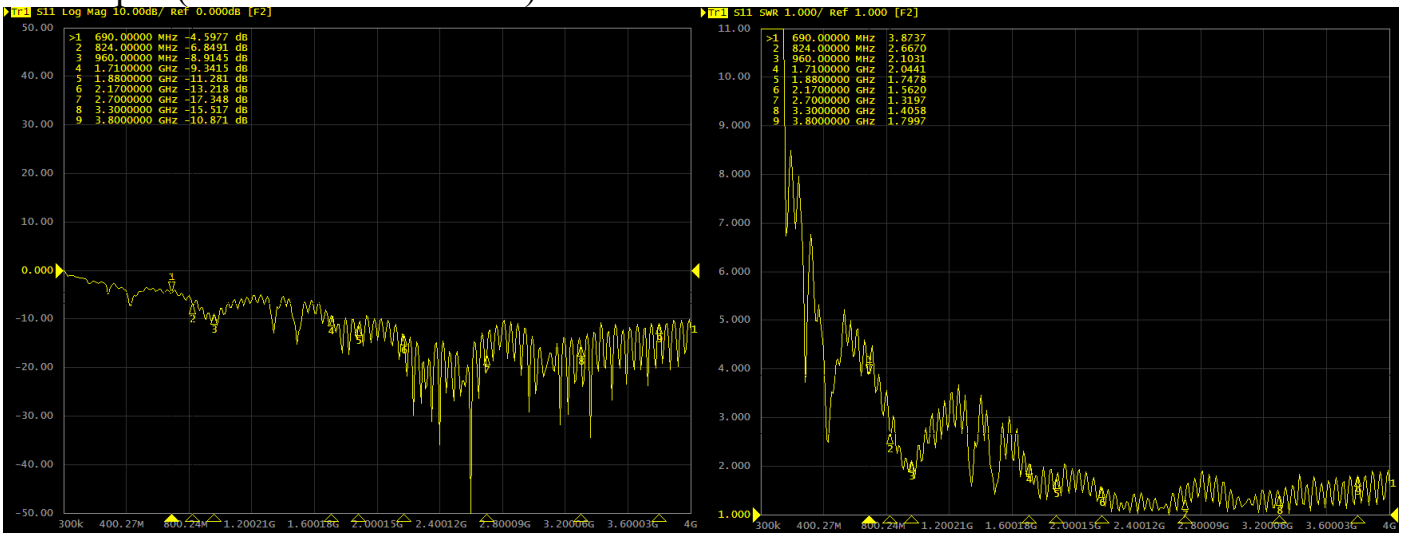

Test Photo

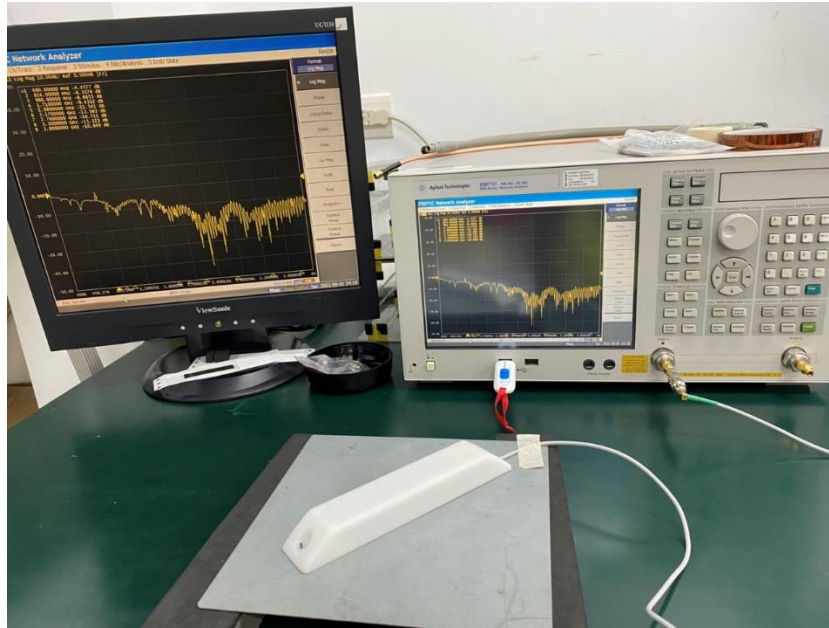

3D Test Photo

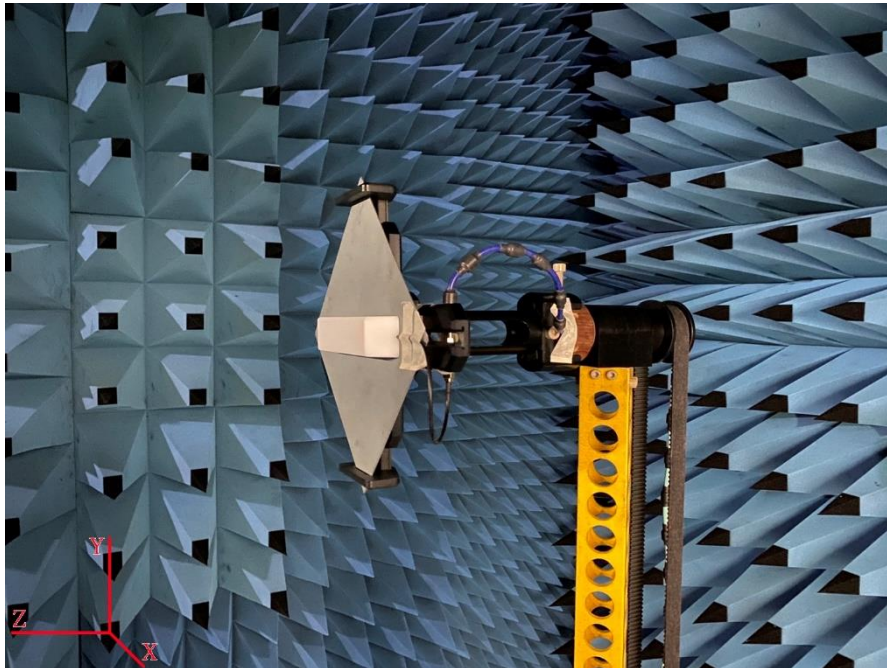

3D Test Data

Freq. / Chan.	Color
690MHz	Red
824MHz	Green
960MHz	Magenta
1.71GHz	Cyan
1.88GHz	Yellow
2.17GHz	Black
2.7GHz	Dark Green
3.3GHz	Brown
3.8GHz	Blue

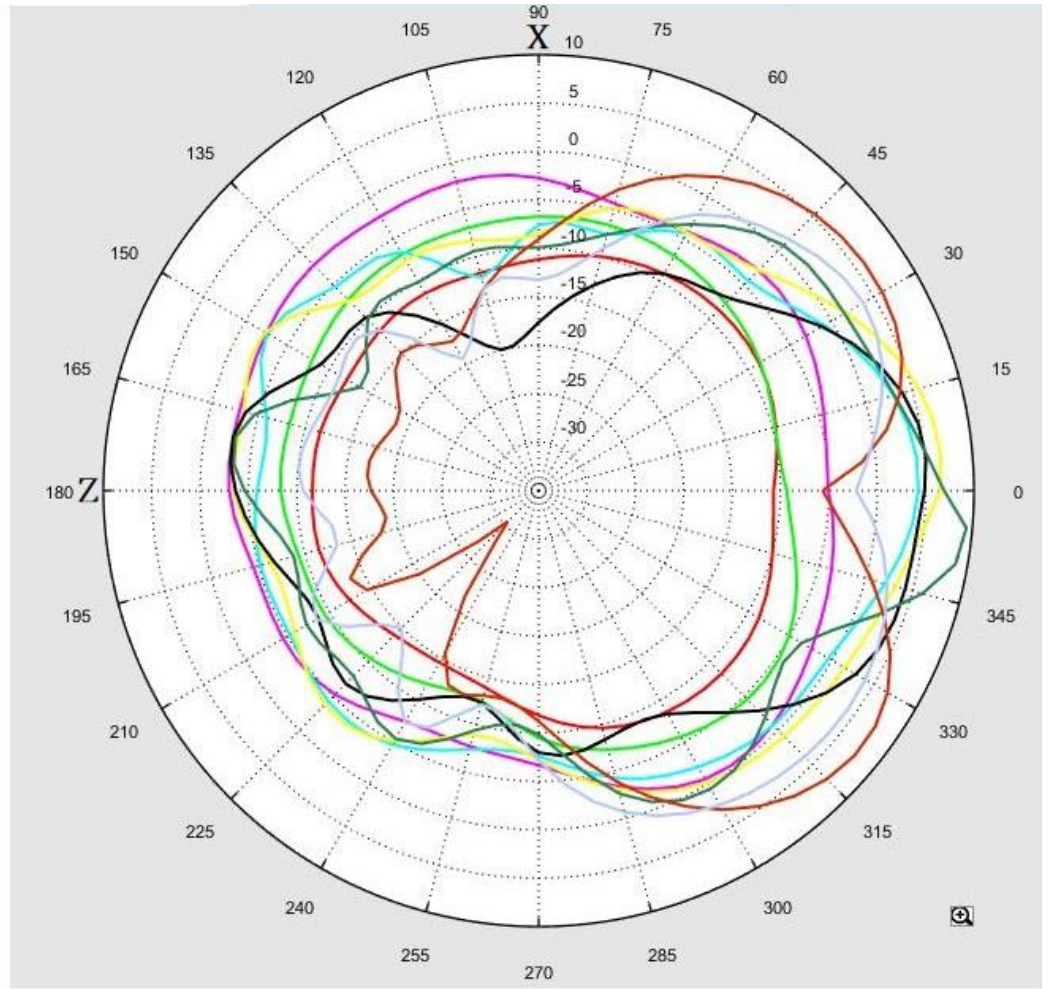

Total_Efficiency (%)

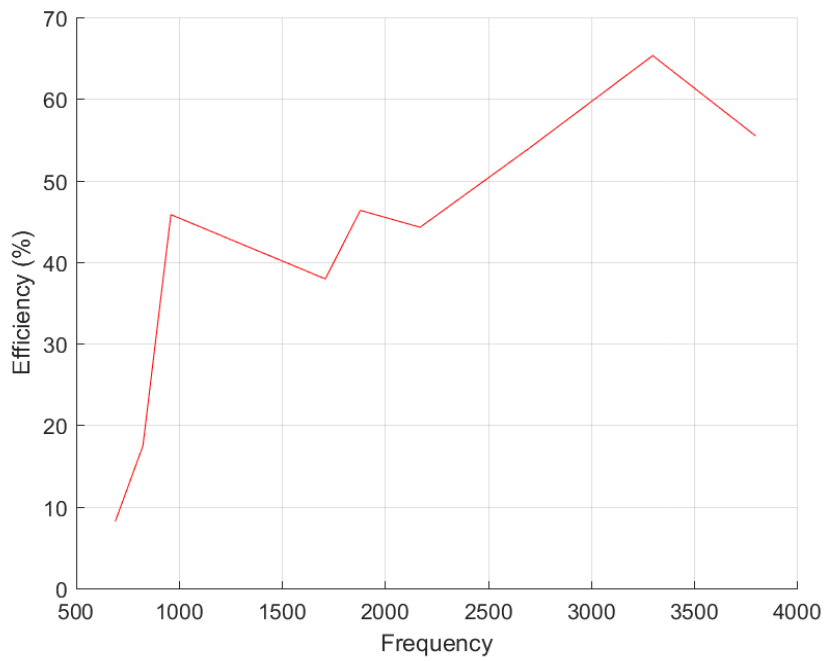

Total_Gain (dBi)

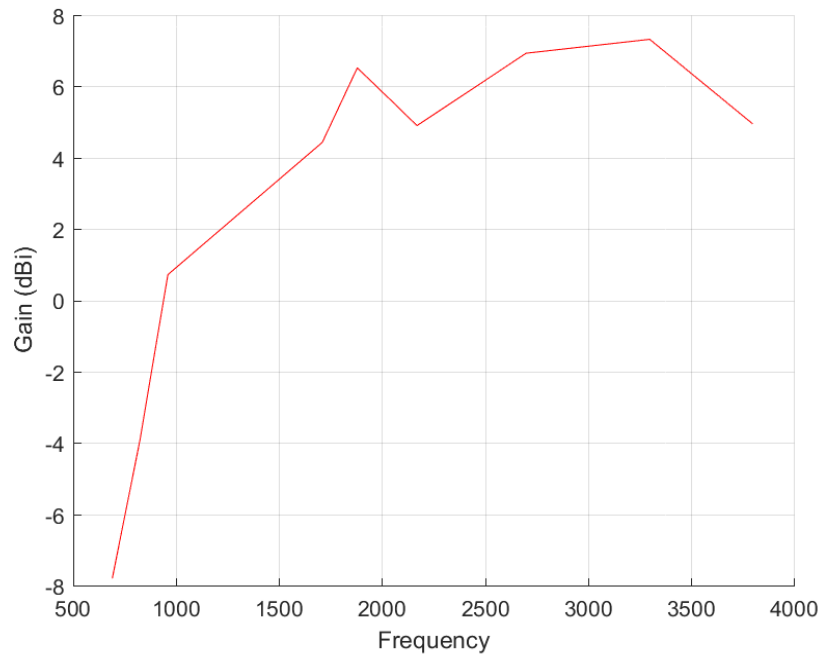

Total_3D_Top View_690MHz

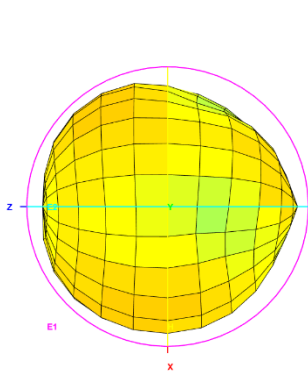

Total_3D_Front View_690MHz

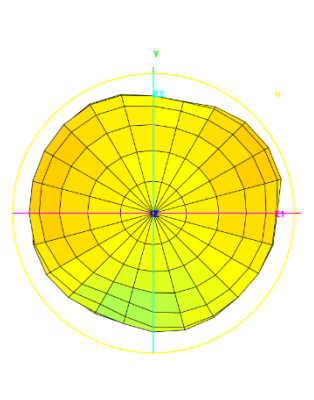

Total_3D_Left View_690MHz

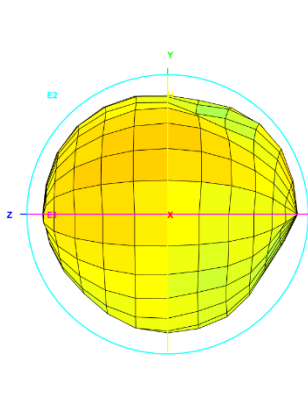

Total_3D_Side View 1_690MHz

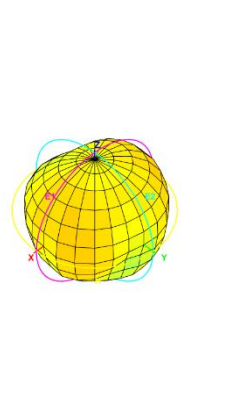

Total_3D_Top View_824MHz

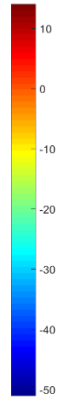
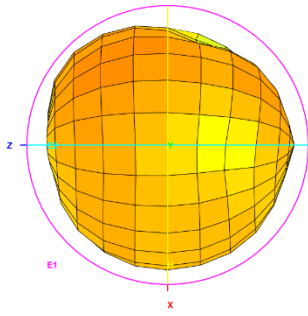

Total_3D_Front View_824MHz

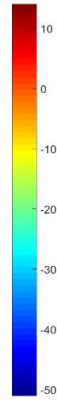
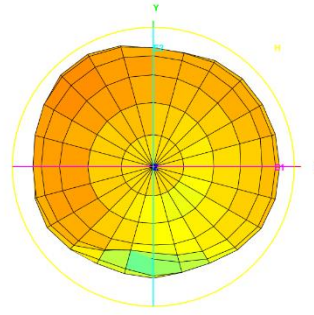

Total_3D_Left View_824MHz

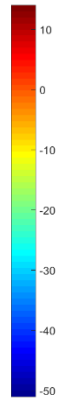
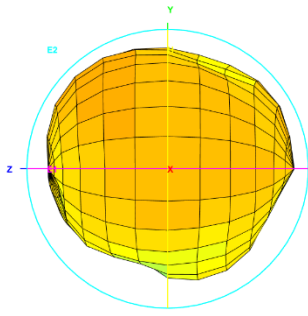

Total_3D_Side View 1_824MHz

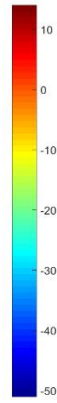
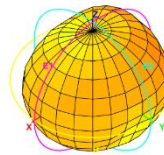

Total_3D_Top View_960MHz

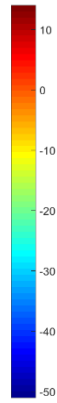
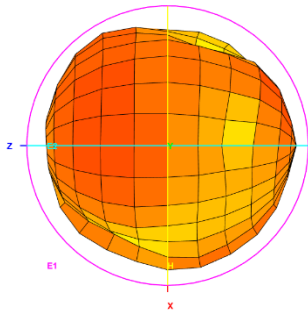

Total_3D_Front View_960MHz

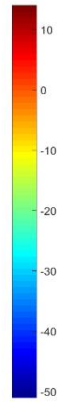
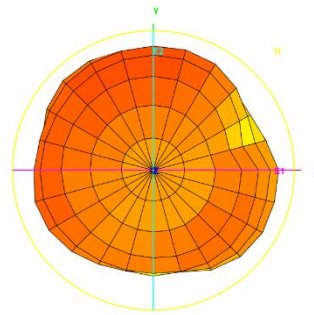

Total_3D_Left View_960MHz

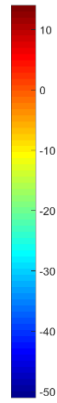
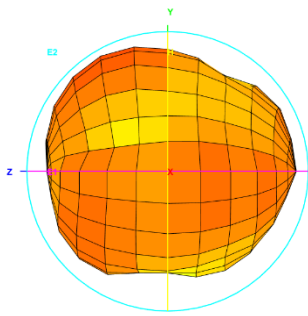

Total_3D_Side View 1_960MHz

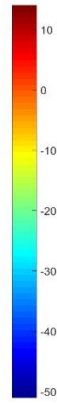
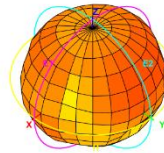

Total_3D_Top View_1.71GHz

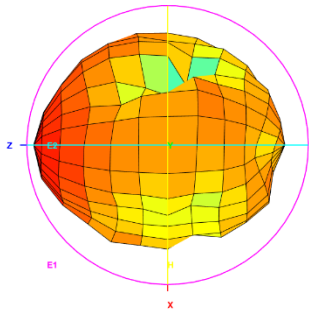

Total_3D_Front View_1.71GHz

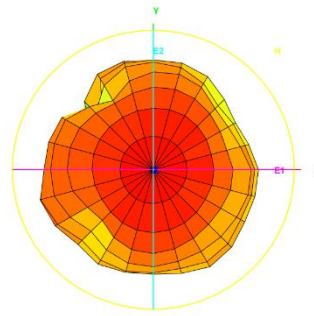

Total_3D_Left View_1.71GHz

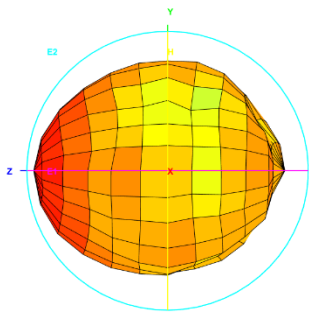

Total_3D_Side View_1.71GHz

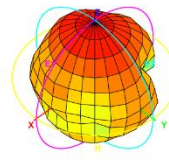

Total_3D_Top View_1.88GHz

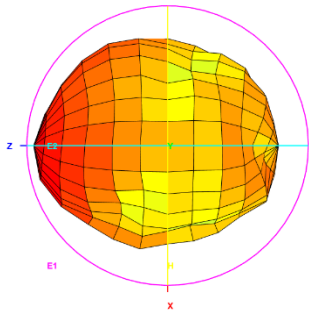

Total_3D_Front View_1.88GHz

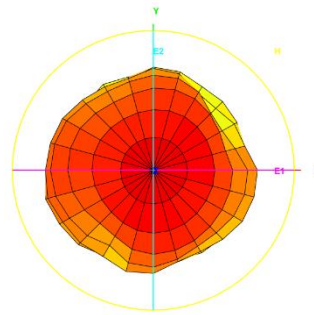

Total_3D_Left View_1.88GHz

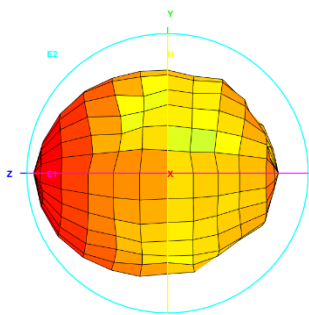

Total_3D_Side View_1.88GHz

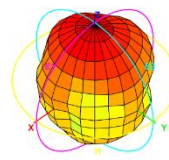

Total_3D_Top View_2.17GHz

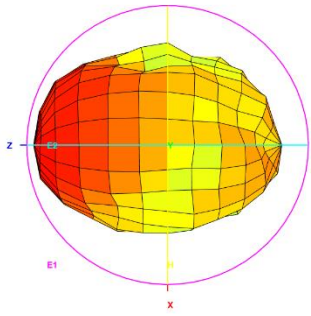

Total_3D_Front View_2.17GHz

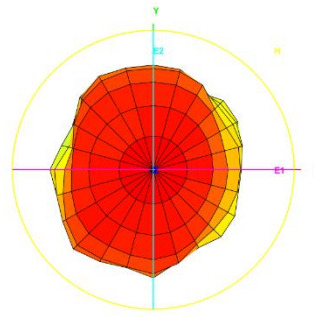

Total_3D_Left View_2.17GHz

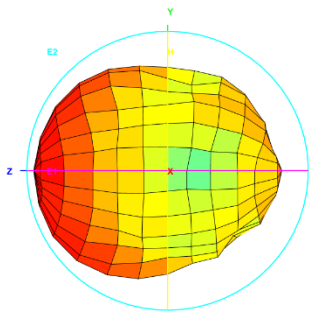

Total_3D_Side View 1_2.17GHz

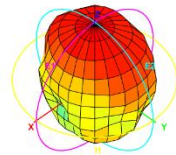

Total_3D_Top View_2.7GHz

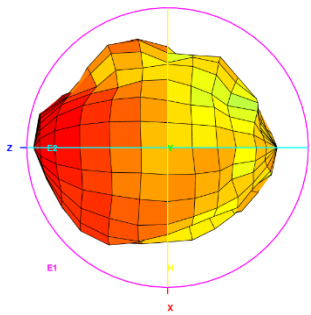

Total_3D_Front View_2.7GHz

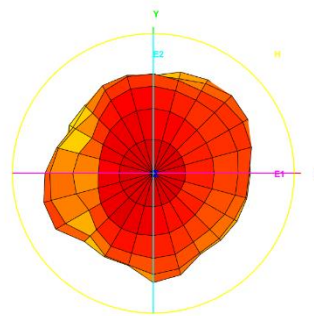

Total_3D_Left View_2.7GHz

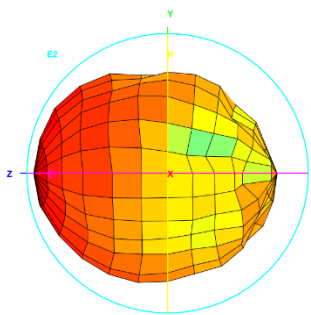

Total_3D_Side View 1_2.7GHz

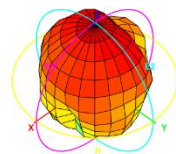

Total_3D_Top View_3.3GHz

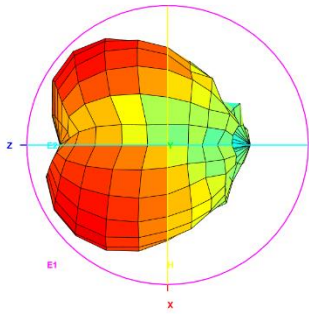

Total_3D_Front View_3.3GHz

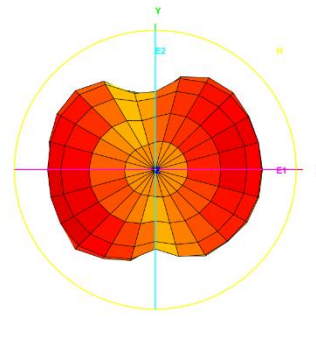

Total_3D_Left View_3.3GHz

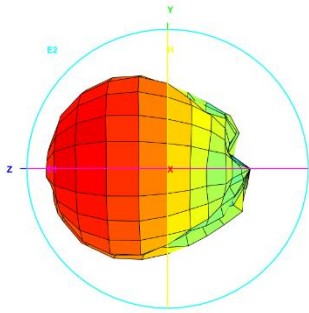

Total_3D_Side View 1_3.3GHz

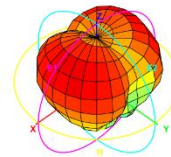

Total_3D_Top View_3.8GHz

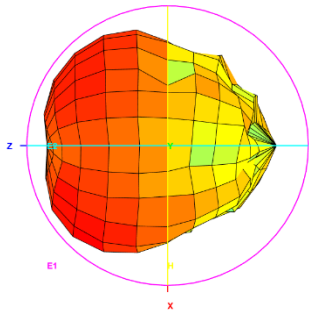

Total_3D_Front View_3.8GHz

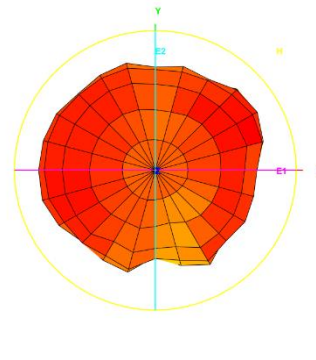

Total_3D_Left View_3.8GHz

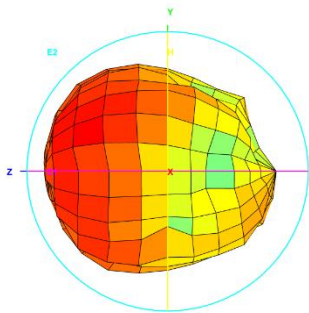

Total_3D_Side View 1_3.8GHz

